

SIEMENS

8BK80

Genuine metal-clad single busbar switchgear with Vacuum Circuit Breaker on withdrawable truck upto 36kV



Fully Typed Tested
including
Internal Arc Test

SIEMENS



Switching Device Compartment for Partners - Ivac

36kV, 26.3kA, upto 1250A with 3AH03 Vacuum Circuit Breaker

www.siemens.co.in

Answers for infrastructure and cities.

Advantages of Vacuum over other interrupting media:

- Highest dielectric strength over a small contact gap
- Constant low contact resistance
- Fastest recovery strength
- Lowest arc energy dissipation
- Lowest drive energy requirements
- Minimum contact erosion
- No fire hazards or explosion risks
- Least number of moving parts and hence highest reliability

Construction

The 3AH03 compact and reliable vacuum circuit breakers consist of three poles incorporating the vacuum interrupters housed in insulated shell. These poles are then covered with insulated pole cover from behind to make the design completely enclosed. The moving contacts of the vacuum interrupter are connected to the drive mechanism through insulated connecting rods. Operating mechanism is of stored energy type and suitable for auto reclosing duty. The operation can be manual/electrical as desired. 3AH03 Vacuum Circuit Breaker is housed inside 2 mm thick powder coated sheet metal with fully safety-interlocked door & bushings for taking further connections by the Partner.

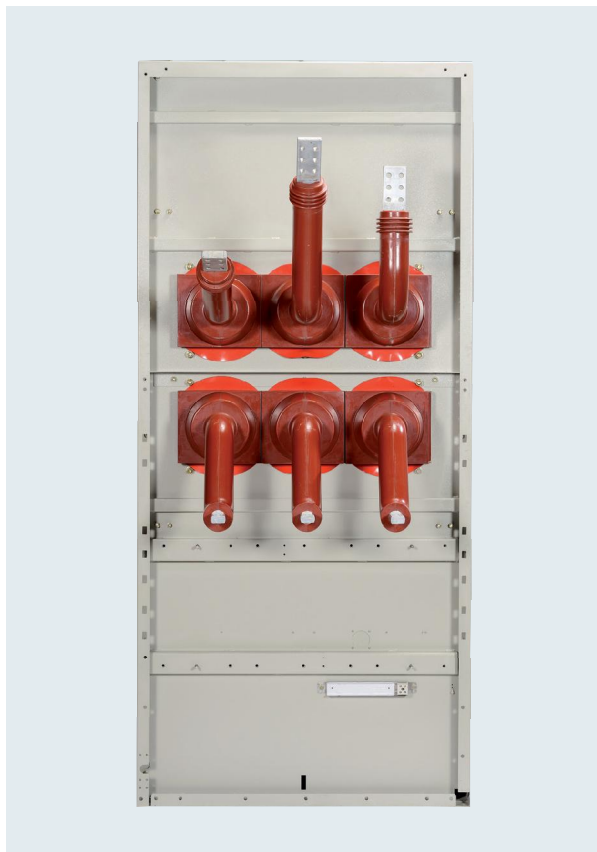

Salient features of 3AH03 Vacuum Circuit Breaker

- Conforms to IEC 62271-100 and is fully type tested
- Simple and compact design
- Interrupters housed inside an enclosed insulated pole
- Totally restrike free
- Suitable for rapid auto reclosing
- Highly reliable operation
- Long maintenance free life
- High switching capability
- Fully established for all applications
- Matching drive and interrupter characteristics
- Trolley mounted for the ease of handling

Partner's Benefits

- Modular design, enabling Partner's ease for further panel development
- Fully type tested switchgear
- Most compact design
- Lower design cost
- Maintenance free new generation interrupters from Siemens

Technical Data

Ivac with 3AH03 Vacuum Circuit Breaker		
Rated Voltage	upto 36kV	
One minute power frequency withstand voltage (rms)	70kV	
1.2/50 micro second lightening impulse withstand voltage	170kVp	
Rated current	1250A	
Short Time Withstand current (3 sec)	26.3kA	
Short Circuit Breaking current	26.3kA	
Rated making capacity	65.75kA	
Rated Operating sequence	O-0.3sec-CO-3min-CO	
Single capacitor bank breaking current	400A	
Cable charging breaking current	50A	
Guaranteed number of operations for vacuum interrupter at rated current	30,000	
Guaranteed number of operations for drive mechanism	10,000	
Is CB restrike free	Yes	
Type of operating mechanism	Motor Spring Reserve Drive (M.S.R.D.)	
Dimensions	Height	2250 mm
	Width	1000 mm
	Depth	1245 mm

Switching application

Ivac with 3AH03 VCB is well suitable for medium voltage power distribution applications like transformer feeder, line feeder in various industries, infrastructure projects and power utilities.

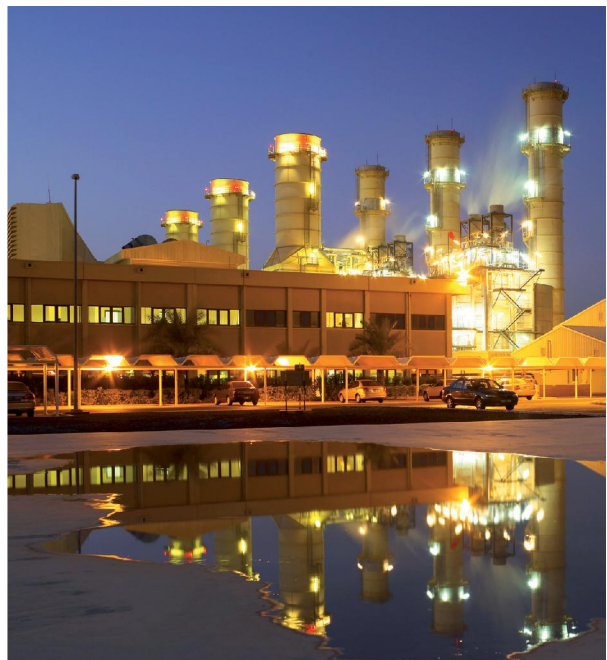

For more information, please contact:

Western Region

Mumbai

HO-B, Building No.2, 1st Floor
130, Pandurang Budhkar Marg, Worli
Mumbai - 400 018, Maharashtra (India)
Tel.: +91-22-3967 7866

Vadodara

"Vishwakarma Bhavan"
Ground Floor, Maneja Works
Vadodara - 390 013
Tel.: +91-0265-395 7701

Pune

701-705, ICC Trade Tower
B Wing, Senapati Bapat Marg
Pune - 411 016, Maharashtra (India)
Tel.: +91-20-3046 6039

Eastern Region

Kolkata

43, Shantipalli
E.M. Bypass, Rash Behari Connector
Kolkata - 700 042
Tel.: +91-33-3093 9683

Northern Region

Gurgaon

3rd Floor, Tower - B
Plot No. 6-A, Sector - 18
Maruti Industrial Area, HUDA
Gurgaon - 122 015, Haryana (India)
Tel.: +91-124-383 7377

Southern Region

Chennai

9th Floor, Sigaphi Achi Building
18/3, Rukmani Lakshmi pathi Road, Egmore
Chennai - 600008
Tel.: +91-44-3342 6215

Siemens Ltd.
Infrastructure & Cities Sector
Power Distribution - Medium Voltage
R&D Building
Thane Belapur Road
Thane - 400 601, India
Tel.: +91 22 3326 5005

XX-XX-XXX-XXX

www.siemens.com/medium-voltage-devices

Printed in India

Product upgradation is a continuous process. Hence, data in this catalog is subject to change without prior notice. For the latest information, please get in touch with our Sales Offices.

SIEMENS

ROUTINE TEST CERTIFICATE

Client	: PRADIP POWERTECH PVT LTD		
W. O. No.	: 3003870404/200	Sr. No.	N8 19767
MLFB	: 3AH03142AEEAAKF2	Interrupter Type	VS 36025
C. B. Rating	: 36kV,26.3kA,1250A	Date	14/06/2014
Motor Mechanism	: 230V AC		
Spring Charge Time	: 9.09 Sec.	at Ua 0.85	: 11.00 Sec.
Current Input	: 1.27 Amp.	at Ua 0.85	: 1.13 Amp.
Closing Solenoid	: 110V DC	Type	: 3AY1510Y
OPERATES SATISFACTORILY AT 0.85 Ua AND 1.1 Ua			
Opening Solenoid	: 110V DC	Type	: 3AY1510Y
Additional Release	: N.A.	Type	: N.A.
OPERATES SATISFACTORILY AT 0.70 Ua AND 1.1 Ua			
Closing Time	: 67.4 msec	OpeningTime	: 45.5 msec
		OpeningTime	: msec
mV DROP at 100 Amp	: R	Y	B
	4.3mV	4.2mV	4.3mV
MECHANICAL OPERATING TESTS : CHECKED OK			
HV TEST ON AUX. CIRCUITS	: 2 kV/min	OK	
HV TEST ON MAIN CIRCUITS	: 70kV/min	OK	
THE EQUIPMENT COMPLIES WITH SPECIFICATIONS OF IEC 62271-100 AND IS 13118. COMPLIANCE WITH ABOVE SPECIFICATION HAS BEEN CHECKED BY ROUTINE TESTING IN TEST LABORATORY			
Note:			
Print Date: 17/06/2014		Siemens Ltd. Quality Assurance ED-MV/Q	
ENERGY DISTRIBUTION DIVISION THANE-BELAPUR ROAD			
P. O. BOX 85, THANE(MAHARASHTRA) INDIA.			
PIN - 400 601.			
TEL - +91-22-2762 3975 FAX - +91-22-2762 3710.			
This is a computer generated document, hence do not require signature.			

ROUTINE TEST CERTIFICATE

Client	: PRADIP POWERTECH PVT LTD		
W. O. No.	: 3003870404/200	Sr. No.	N8 19768
MLFB	: 3AH03142AEEAAKF2	Interrupter Type	VS 36025
C. B. Rating	: 36kV,26.3kA,1250A	Date	06/06/2014
Motor Mechanism	: 230V AC		
Spring Charge Time	: 8.49 Sec.	at Ua 0.85	: 10.52 Sec.
Current Input	: 1.31 Amp.	at Ua 0.85	: 1.17 Amp.
Closing Solenoid	: 110V DC	Type	: 3AY1510Y
OPERATES SATISFACTORILY AT 0.85 Ua AND 1.1 Ua			
Opening Solenoid	: 110V DC	Type	: 3AY1510Y
Additional Release	: N.A.	Type	: N.A.
OPERATES SATISFACTORILY AT 0.70 Ua AND 1.1 Ua			
Closing Time	: 66.5 msec	OpeningTime	: 43.1 msec
		OpeningTime	: msec
mV DROP at 100 Amp	: R	Y	B
	4.5mV	4.4mV	4.7mV
MECHANICAL OPERATING TESTS : CHECKED OK			
HV TEST ON AUX. CIRCUITS	: 2 kV/min	OK	
HV TEST ON MAIN CIRCUITS	: 70kV/min	OK	
THE EQUIPMENT COMPLIES WITH SPECIFICATIONS OF IEC 62271-100 AND IS 13118. COMPLIANCE WITH ABOVE SPECIFICATION HAS BEEN CHECKED BY ROUTINE TESTING IN TEST LABORATORY			
Note:			
Print Date: 17/06/2014		Siemens Ltd. Quality Assurance ED-MV/Q	
ENERGY DISTRIBUTION DIVISION THANE-BELAPUR ROAD			
P. O. BOX 85, THANE(MAHARASHTRA) INDIA.			
PIN - 400 601.			
TEL - +91-22-2762 3975 FAX - +91-22-2762 3710.			
This is a computer generated document, hence do not require signature.			



SWITCHBOARD TEST CERTIFICATE

CLIENT	: Pradip Powertech Pvt Ltd.	
PROJECT	:	
W.O.NO.	: W003870404	ITEM NO. : 200
SALES OFFICE REF.	: 3003868515	
BOARD DISCRPTION	: NA	
SYSTEM	: 3Phase, 3Wire, 50Hz	VOLTAGE : NA
AUXILIARY VOLTAGE	: -V DC, -V AC	
RECORD OF DRG. Nos.	: NA	
BOARD TYPE	: 8BK80RD	No. Of PANELS : 2
I INSULATION RESISTANCE TEST :		
All the values are in Mega Ohms		
1 POWER CIRCUIT	: : With 5KV Megger : between phases	> 5000 in M Ohms
	: Between Phases >	5000 in M Ohms
2 AUX CIRCUIT	: NA	
II HIGH VOLTAGE TEST :		
1 POWER CIRCUIT	: Between Phases & Between Phase & Earth Main circuit withstood	70 kv for 1 min
2 AUX CIRCUIT	: NA	
III VERIFICATION OF WIRING : CONFORMS TO WIRING DRAWINGS		
IV OPERATION TEST : (At no load) - SATISFACTORY		
TEST CONFORM TO	: IS 3427; IS 12729; IEC 62271-200; IEC 60694	
COMMENTS	: Refer Annexure for contact resistance	
Date :	4-Jul-14	 SWITCHBOARD WORKS - KALWA

SIEMENS LTD.

Infrastructure & Cities
Thane BelapurRoad,
P.O.Box No.85
Thane 400 601

Air Insulated Switching Device Compartment Ivac - 36kV, 26.3kA, 1250A

For Indoor Applications on Withdrawable Circuit Breaker Truck with the
system voltages 24kV & 36kV





Table of Contents

	Page Nos		Page Nos
1. Technical Description		4. Operations	
1.1 General	4	4.1 Withdrawable Truck	20
1.1.1 Application	4	4.1.1 Positions of the withdrawable truck	20
1.1.2 Specific Standards	4	4.1.2 Transferring the Withdrawable Part from the test / disconnected position manually	20
1.1.3 Ambient Temperature and Humidity	4	4.1.2.1 Normal Operations	20
1.2 Design Features	4	4.1.3 Transferring the Withdrawable Part from the Connected position to the test / disconnected position manually	20
1.2.1 Circuit Breaker Compartment	4	4.1.3.1 Normal Operations	20
1.2.1.1 Vacuum Circuit Breaker	4	4.1.3.2 Castell Key Operation	20
1.2.1.2 Equipment	6	4.1.4 Removing the LV Plug	21
1.2.1.3 Motor Operating Mechanism (MI)	7	4.1.5 Connecting the LV Plug	21
1.2.1.4 Closing Release (Y9) 3AY1510Y	7	4.2 Circuit Breaker Operating Mechanism	21
1.2.1.5 Shunt Releases (Shunt opening releases)	7	4.3 Circuit Breaker Operation	21
1.2.1.6 Socket for low voltage plug connector	8	4.3.1 Charging the closing spring by hand	21
1.2.1.7 Auxiliary switch (S1) 3SV92	8	4.3.1.1 Breaker ON and OFF	21
1.2.1.8 Mechanical interlock 3AX1520-2C	8	4.3.1.2 Mechanically	21
1.2.1.9 Service Position	9	4.3.1.3 Electrically	21
1.2.1.10 Test Position	9	4.3.2 Switching State Indication	21
1.2.1.12 Removed Position	9	4.4 Earthing	21
1.2.2 Accessories	10	4.4.1 Earthing of Busbars / Cables with a Drawout Truck	21
1.2.3 Interlocks	10	4.4.1.1 Disconnection of Earthing Drawout Truck	21
1.3 Technical Data	10	4.5 Breaker Compartment Door	22
1.3.1 Switching Device Compartment	10	4.5.1 To Open the Door	22
1.3.2 Vacuum Circuit Breaker	10	4.5.2 To Close The Door	22
2. Installation		5. Maintenance	
2.1 Transport Units	12	5.1 Switching Device Compartment	23
2.2 Packing	12	5.1.1 Inspection Schedule	23
2.3 Unloading	12	5.1.2 Cleaning	23
2.3.1 Handling Equipment Required	12	5.1.3 Lubrication	23
2.3.2 Procedure	12	5.2 Vacuum Circuit Breaker	24
2.4 Examining the Switchgear against damages	12	5.2.1 Maintenance Schedule	24
2.4.1 Storage	12	5.2.2 Servicing	25
2.5 Transferring the Transport Units	12	5.2.3 Troubleshooting of 3AH0 VCBs	26
2.5.1 Removing the truck from the panel	12	6 Defecting door interlock of HV compartment	
2.6 Assembling the Switchboard	12	6.1 Drawout unit in connected positions	27
2.6.1 Joining of the Panels	12	6.2 Drawout unit in disconnected positions	27
2.6.2 Fixing the Switchboard to the Foundation	13	6.3 Restoring the door interlock	27
2.7 Earthing of Switchboard	13	7. Disposal of Product	27
2.8 Other Work to be carried out	13	8 Summary of Important Instructions	28
2.8.1 Cleaning the Switchboard	13	9. Additional Information	
2.8.2 Inserting the withdrawable parts	13	9.1 Reference list of Items	29
2.8.3 Protecting the panels against Environmental effects	14	9.2 List of spares 3AH0 VCBs	30
2.9 Module Wiring	14		
2.10 Circuit breaker wiring	14		
3. Putting the Switchgear into Service			
3.1 Test Operations	17		
3.1.1 With Door Open	17		
3.1.2 With Door Closed	19		
3.2 Checking the Accessory Items	19		
3.3 Space Heaters	19		

Safety instructions

Signal terms and definitions

	<p>DANGER! as used in these instructions, this means that personal injuries can occur if the relevant precautionary measures are not taken ⇒ Observe the safety instructions.</p>
	<p>ATTENTION! as used in these instructions, this means that damage to property or environment can occur if the relevant precautionary measures are not taken. ⇒ Observe the safety instructions.</p>
	<p>NOTE! as used in these instructions, this points at facilitations of work, particularities for operation or possible maloperation. ⇒ Observe the notes.</p>

Symbols used

- ☞ Operation symbol: Identifies an operation. Asks the operator to perform an operation.
- ✓ Result symbol: Identifies the result of an operation.

General instructions

Independently of the safety instructions given in these operating instructions, the local laws, ordinances, guidelines and standards for operation of electrical equipment as well as for labor, health and environmental protection apply.

Any kind of modification on the product or alteration of the product must be coordinated with the manufacturer in advance, as uncoordinated modifications or alterations can cause the expiration of warranty claims, cause danger to life, limb and other legally protected interests, and the fulfillment of the type tests (according to IEC 62271-200) may not be guaranteed anymore.

The edition of the standard is only mentioned in the test report applicable at the time of switchgear manufacture.

Five Safety Rules of Electrical Engineering

The Five Safety Rules of Electrical Engineering must generally be observed during operation of the products and components described in these operating instructions:

- Isolate.
- Secure against reclosing.
- Verify safe isolation from supply.
- Earth and short-circuit.
- Cover or barrier adjacent live parts.

Due application

The switchgear corresponds to the relevant laws, prescriptions and standards applicable

at the time of delivery. If correctly used, they provide a high degree of safety by means

of logical mechanical interlocks and shockproof metal enclosure of live parts.

	<p>DANGER! The perfect and safe operation of this switchgear is conditional on:</p> <p>Observance of operating and installation instructions.</p> <p>Qualified personnel.</p> <p>Proper transportation and correct storage of the switchgear.</p> <p>Correct installation and commissioning.</p> <p>Diligent operation and maintenance.</p> <p>Observance of the instructions applicable at site for installation, operation and safety.</p>
---	--

Qualified personnel

Qualified personnel in accordance with these instructions are persons who are familiar with maintenance and operation of the product and have appropriate qualifications for their work.

Furthermore, qualified personnel must have the following training and instruction or authorization:

- Training and instruction or authorization to switch on, switch off, earth and identify power circuits and equipment I systems as per the relevant safety standards
- Training and instruction regarding the applicable specifications for the prevention of accidents and the care and use of appropriate safety equipment
- Training in first aid and behavior in the event of possible accidents

1. Technical Description

1.1 General

Switching Device Compartment is of horizontal isolation & horizontal drawout type, for indoor applications, for system voltage upto 36kV. The design incorporates the set of interlocks for safe operation of switchgear.

1.1.1 Application

The switchgear is suitable for use as distribution unit for switching load at substations of electric supply companies as well as for power stations & industrial plants.

1.1.2 Specific Standards

The Switching Device Compartment is designed to meet basic specifications as per IEC 62271-100 and 200 wherever applicable. Complete testing as per IEC 62271-200 is OEM responsibility.

1.1.3 Ambient Temperature, Humidity and Installation Altitude:

The ambient temperature, the switchboard has been designed for, is stated in the rating plate.

Permissible atmospheric humidity
Relative humidity 24 hours mean max 95%.
Relative humidity 1 month means max 90%

Maximum Installation Altitude of Switching Device Compartment is 1000m above mean sea level.

1.2 Design Features

1.2.1 Circuit Breaker Compartment

The circuit breaker compartment contains a withdrawable truck with Vacuum Circuit Breaker or Bus PT Truck. The breaker terminals are fitted with contact arms (Fig 3a & 3b)

1.2.1.1 Vacuum Circuit Breaker

The main features of the 3AH0 vacuum circuit-breaker are shown in Fig. 3b.

The mechanism housing (3.9) accommodates all electrical and mechanical elements required for opening and closing the vacuum circuit-breaker. Fig. 3c shows the arrangement of the individual modules in the mechanism housing.

The mechanism housing has a detachable cover (3.47) (Fig. 3d).

This cover (3.47) has cutouts for the actuating and indicating devices.

The vacuum circuit-breaker can be closed by means of the push button (3.1). The motor (3.18) immediately recharges the closing spring (3.31). In the event of motor power supply failure, the closing spring can be charged by means of a hand crank. The cover includes an opening for the hand crank, behind which the hand crank coupling of the gear box is located. The stored-energy mechanism state is shown by the indicator (3.26). The indicator (3.28) shows the breaker state (ON - OFF). The operating cycle counter (3.27) indicates the

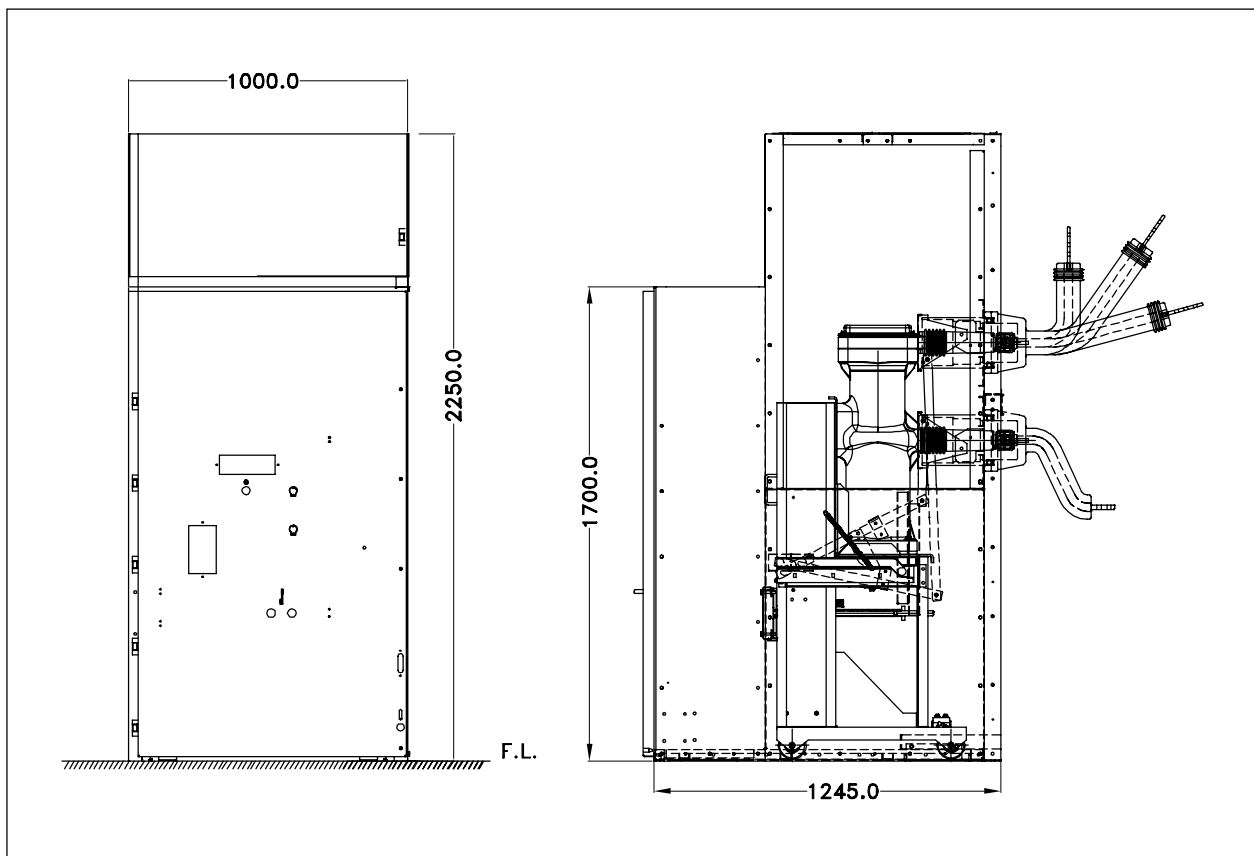

Fig 1: Switching Device Compartment

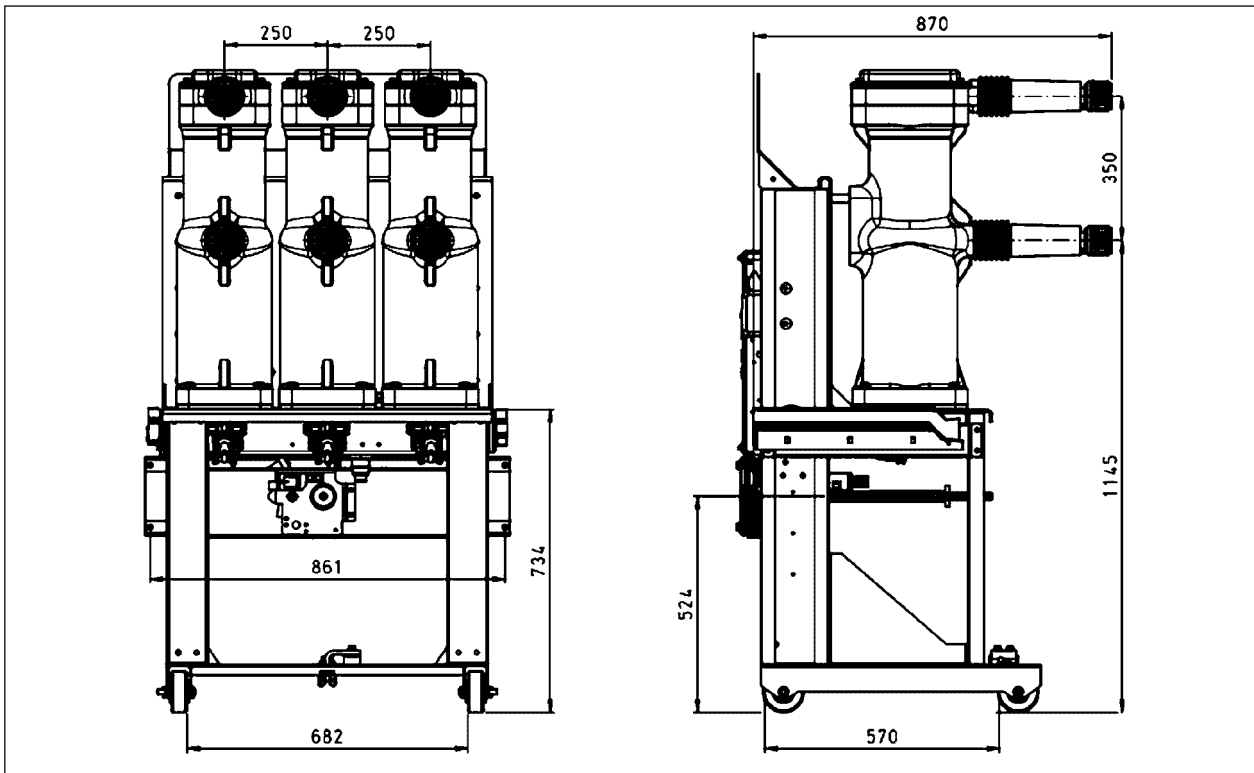

Fig 2: 36kV breaker

number of ON-OFF charging operations. The rating plate (3.20) is attached to the gear box but is visible through an opening in the cover.

The movement of the switching shaft is transmitted to the pole assemblies via linkage assembly (3.11).

The pole assembly consists of the top terminal (3.13) with the tulip assembly (3.14), the vacuum interrupter (3.10), the tulip assembly (3.14) with the bottom terminal (3.14), flexible current link (3.16).

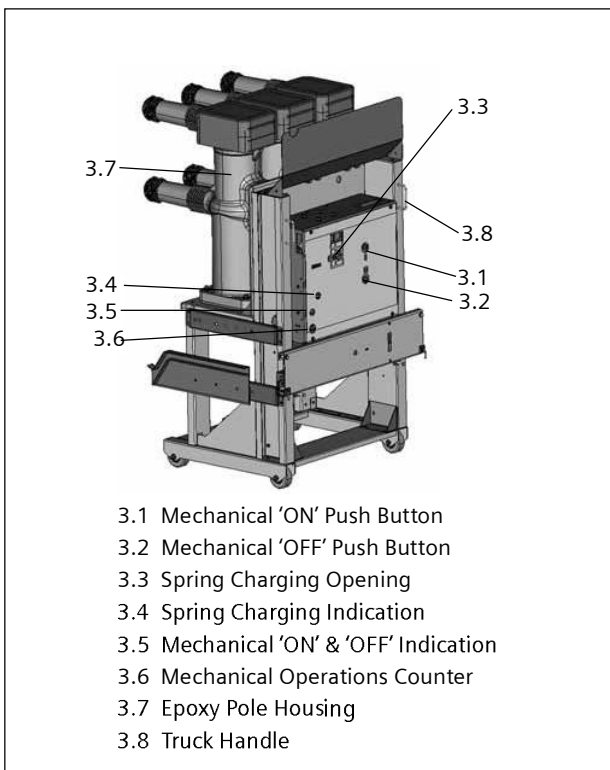

Fig 3a: Withdrawable truck with 3AH0 Vacuum Circuit Breaker

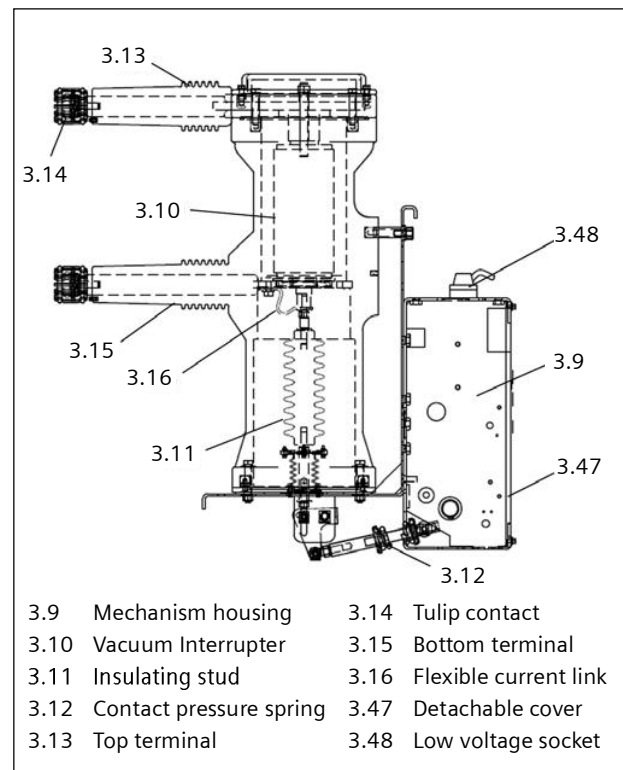

Fig 3b: 3AH0 Vacuum Circuit Breaker

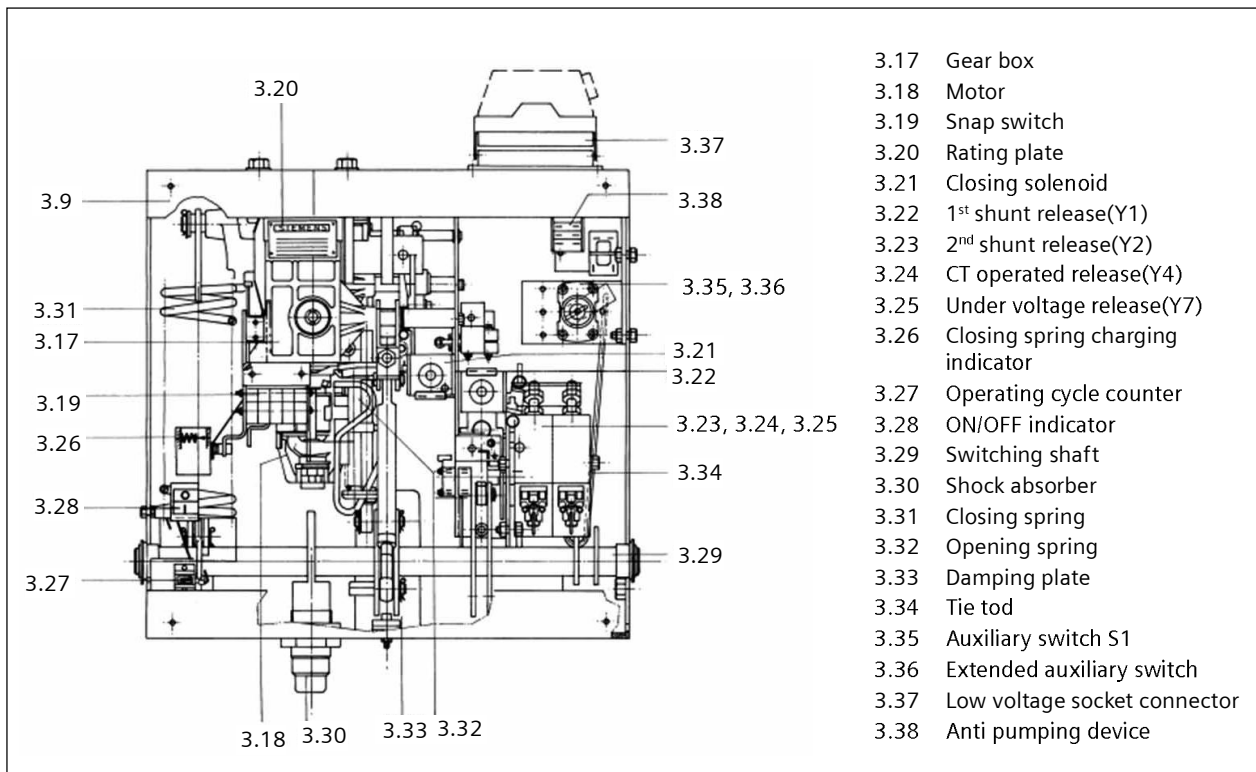

Fig 3c: View of an open mechanism housing

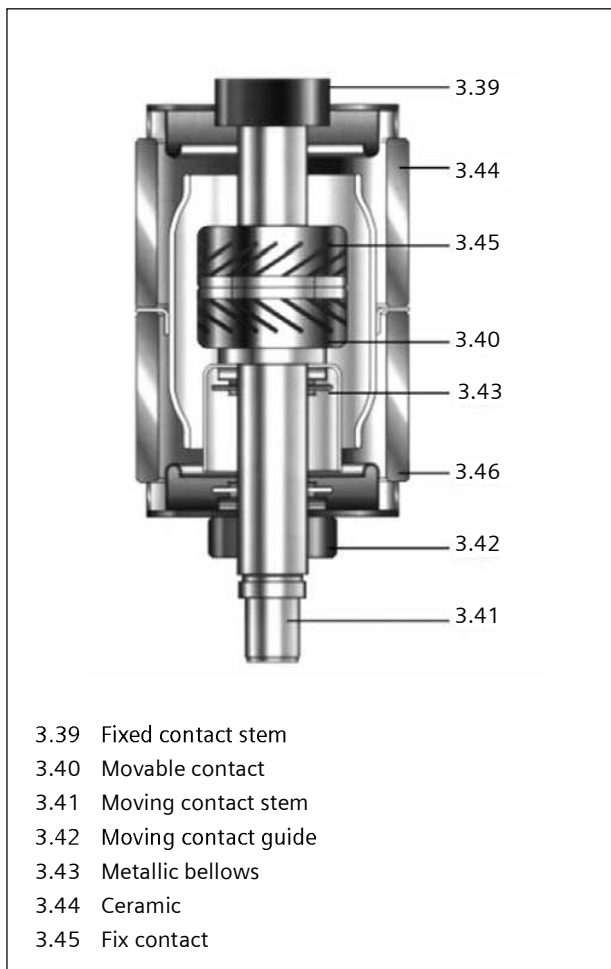

Fig 3d: Vacuum Interrupter

Vacuum interrupters

The basic construction of the vacuum interrupters for the 3AH0 vacuum circuit-breaker is shown in the sectional view in Fig. 3d

The vacuum interrupter (3.10) is fixed to the top terminal. The fixed contact stem (3.39) is connected directly with the interrupter housing. The moving contact (3.40) is fixed to the moving contact stem (3.41) and is located centrally in the moving contact guide (3.42). The metallic bellows (3.43) forms the vacuum-proof connection to the interrupter housing.

The vacuum interrupters fitted in the 3AH0 vacuum circuit-breakers are type-approved in accordance with the X-ray regulations of the Federal Republic of Germany. They conform to the requirements of the X-ray regulations of January 8, 1987 (Federal Law Gazette Page 144) 8 and Annex III Section 5 up to rated short-time AC voltage stipulated in accordance with DIN VDE/IEC.

1.2.1.2 Equipment

The basic version of the vacuum circuit-breaker comprises:

- Electrical operating mechanism (charging motor) with electrical anti-pumping feature (M1)
- Closing release (Y9)
- 1st Shunt release (Y1)
- Socket for low-voltage plug connector, 32-pins (X0)
- Auxiliary switch, 6NO + 6NC (S1)
- Position switch for signalling "Closing spring charged" (S41)
- Operating cycle counter

Each 3AH0 vacuum circuit-breaker can be also optionally equipped with the following devices:

- Low voltage-64 terminal socket..... (X0)
- Extended auxiliary switch 12NO + 12NC (S1)
- 2nd shunt release 3AY15 10 (Y3)
- 2nd Shunt release 3AX 1101..... (Y2)
- Current transformer-operated release
3AX 1102 (Y4)
- Undervoltage release 3AX 1103..... (Y7)
- Mechanical interlock

In addition to the standard shunt release (Y1), the 3AH0 vacuum circuit-breaker can be fitted with either Y3 or maximum of two releases of type 3AX 11.

The permissible combinations of supplementary equipment and special versions are stated on page 10.

1.2.1.3 Motor operating mechanism (M1)

The maximum DC power input is 770 W (approx.). The maximum AC power input is 900 VA (approx.). During part of the short spring charging time the motors operate in the overload range. The recommended ratings for motor protection devices are shown in Fig. 7 (the protection devices are not supplied with the vacuum breakers and must be ordered separately).

Rated supply voltage	DC 24 V	DC 48 V	DC 60 V	DC/AC 110 V 50/60 Hz	DC 220 V/ AC 230 V 50/60 Hz
Recommended rating of protection device*)	16 A	8A	6A	5A ¹⁾	2.5 A ¹⁾

*) MCB with G characteristic.

1) Also lower values are applicable : 3A/1.6A

Table 1: Rated currents of motor protection devices

The supply voltage may deviate from the rated value by - 15% to + 10%.

1.2.1.4 Closing release (Y9) 3AY1510Y

The closing solenoid unlatches the charged closing spring and thus closes the circuit-breaker electrically. It is available for both AC and DC operation. After completion of a closing operation, the closing solenoid is de-energized internally. In operation with AC voltage, a rectifier module 3AX1525 is installed in the circuit-breaker.

Power consumption 200 W/VA

1.2.1.5 Shunt releases (shunt opening releases)

The shunt releases are used for automatic tripping of circuit-breakers by means of appropriate protective relays and for deliberate tripping by other electrical means. They are designed for connection to external voltage (DC or AC voltage). In special cases, for deliberate tripping, they can also be connected to a voltage transformer.

Shunt releases based on two different operating principles are used.

Basic 1st Shunt release (Y1) 3AY1510Y

The 3AY1510 shunt release is used as standard in the basic circuit-breaker version. With this design, the electrically supplied tripping pulse is passed to the "Open" latching mechanism by means of a direct-action solenoid armature and the circuit-breaker is thus opened. It is available for both AC and DC operation. After completion of an opening operation, the 3AY1510 shunt release is de-energized internally. In operation with AC voltage, a rectifier module 3AX1525 is installed in the circuit-breaker.

Power consumption 200 W/VA

Supplementary 2nd Shunt release (Y3) 3AY15 10Y*)

This release is used if more than one shunt release is required to ensure opening of the breaker in case of failure of first shunt release. The voltage of this release hence can be same or different than first shunt release. This release is dimensionally & functionally same as first shunt release.

Power consumption 200W/VA

Supplementary 2nd Shunt release (Y2) 3AX1101*)

The 3AX1101 shunt release is fitted if more than one shunt release is required. With its design, the electrical opening command is transferred in boosted form to the "Open" latching mechanism via a solenoid armature through unlatching of a energy store and thus, the circuit-breaker is opened. The stored energy mechanism is automatically recharged by the circuit-breaker.

Power consumption =/ < 60 W or =/ < 47 VA

Supplementary Under voltage release (Y7) 3AX1103*)

Undervoltage release consist of a stored-energy mechanism, an unlatching mechanism and an electromagnet system which is connected continuously to the supply when the circuit-breaker is in the close state. If this voltage drops to below certain value, the unlatching mechanism is released and opening of the circuit-breaker is thus initiated via the stored-energy mechanism. The stored energy mechanism is automatically recharged by the circuit-breaker.

The deliberate tripping of the undervoltage release generally takes place via an NC contact in the tripping circuit. But it can also be carried out via an NO contact by short-circuiting of the magnet coil. With this type of tripping, the short-circuit current is limited by the built-in resistors.

Undervoltage release can also be connected to voltage transformers. When the operating voltage drops to impermissible low levels, the circuit-breaker is tripped automatically. Power consumption =/ < 15 W or =/ < 13 VA

CT-Operated release (Y4) 3AX1102*)

CT-operated releases consist of a stored-energy mechanism, an unlatching mechanism and an electromagnet system. When the tripping current is exceeded (90% of the CT-operated release rated current) the unlatching device of the stored-energy mechanism is released and thus opening of the circuit-breaker is initiated. The stored energy mechanism is

Release combinations

Basic Equipment		Supplementary release (at additional cost)				
Closing release 3AY15 10	1st Opening release 3AY15 10	2nd Opening release 3AY15 10	2nd Opening release 3AX1101	under-voltage release 3AX1103	C.T. operated release 3AX1102	MLFB No. at 9th position
Y9	Y1	Y3	Y2	Y7	Y4	
1	1					A
1	1	1				E
1	1		1			B or W
1	1		1	1		H
1	1		1		1	D or X
1	1			1		F
1	1			1	1	G
1	1				1	C or Y

* Optional tool, retrofitting possible

Breaking capacity				
AC 40 upto 60 Hz		DC		
Supply Voltage U (V)	Operational current I (A)	Supply Voltage U (V)	Operational current I (A)	
			Resistive load	Inductive load (T=20 ms)
up to 230	10	24	10	10
		48	10	9
		60	9	7
		110	5	4
		220	2.5	2

Table 2: Breaking capacity of 3SV92 aux. switch

automatically recharged by the circuit-breaker. In addition to the primary current transformers, matching transformers are required for application of the CT-operated releases.

Power consumption for 0.5 A and 1 A \leq 6 VA at 90% of the rated current and with open armature.

1.2.1.6 Socket for low-voltage plug connector (X0)

The control elements of the 3AH0 vacuum circuit-breaker provided in the mechanism housing are wired for external connection to the socket (X0). The breaker is provided with either 32-pins or 64-pins.

Note: Further wiring harness from Breaker to the low Voltage and metering compartment is a responsibility of OEM manufacturer.

1.2.1.7 Auxiliary switch (S1) 3SV92

Two versions of the auxiliary switch can be supplied. The standard version is fitted with 6 NO contacts and 6 NC

contacts. The extended version is fitted with 12 NO contacts and 12 NC contacts.

Rated voltage : AC/DC 250 V

Insulation class : C

Current : 10 A

Making capacity : 50 A

1.2.1.8 Mechanical interlocking 3AX1520-2C

The sensing parts of the substation check the switch position of the circuit-breaker and prevent it from closing mechanically and electrically if the associated disconnecter is not in a position to allow safe operation. On the other hand, the disconnecter is prevented from being operated when the circuit-breaker is closed.

The mechanical interlocking facility can also be used to interlock breaker trucks of draw-out breaker parts.

The withdrawable truck can be transferred between the service & test positions behind closed doors using a hand crank.

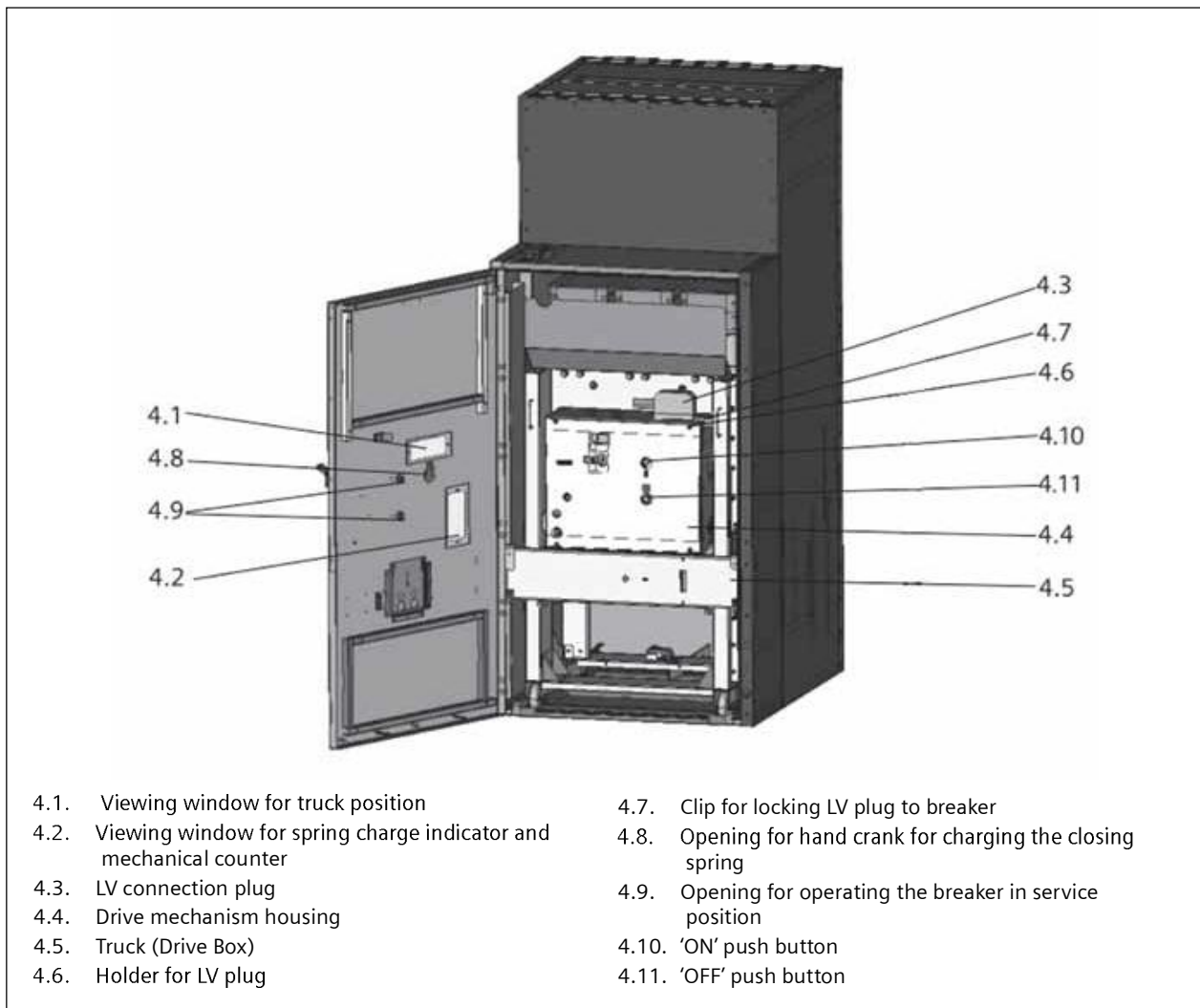

Fig 4: Withdrawable Truck in Test Position & door open

1.2.1.9 Service Position (Connected Position)

The position of a withdrawable truck in which it is fully connected for its intended function. In this position of the truck, the contact arms of the circuit breaker are connected to the busbars as well as to the outgoing cables via the fixed mounted isolating contacts in the panel.

The truck is locked against withdrawing & earthed.

The low voltage circuit is connected through the low voltage plug connection.

1.2.1.10 Test Position

The position of withdrawable truck in which an isolating distance or segregation is established in the main circuit & in which control circuits are connected. In the test position, the truck with the breaker is withdrawn so far between busbars & outgoing cables that there is isolating distance. The truck is locked against moving. The low voltage circuit is connected through low voltage plug connection. Also metallic shutters drop down and cover the bushing of upper & lower mating contact.

The circuit breaker can be tested for all functions.

1.2.1.11 Disconnected Position (Isolated Position)

The position of withdrawable truck in which an isolating distance or segregation is established in the circuits of the withdrawable truck, the truck remaining mechanically attached to the enclosure.

In this position the truck is withdrawn as in test position but the LV plug is disconnected.

In both the test & disconnected positions the contact arms & their mating contacts are separated by metallic shutters.

1.2.1.12 Removed Position

The position of withdrawable truck when it is outside the panel & electrically as well as mechanically separated from it.

Drive Mechanism of the truck is attached to the panel frame using bolts.

The earthing strip at the bottom of the breaker compartment, along with the spring loaded pin provided at the bottom of the circuit breaker truck ensures the earthing of the truck in service, test & disconnected position.

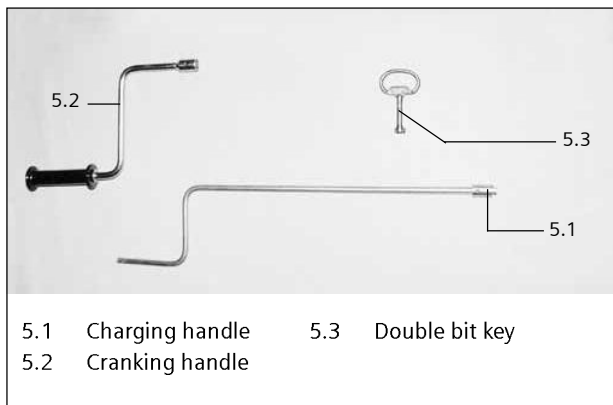

Fig 5: Accessories

1.2.2 Accessories (refer Fig. 5)

Accessories like Spring charging handle, rack in rack out handle, Double bit key and secondary male connector shall be supplied along with the SDC.

1.2.3 Interlocks

The positions of the withdrawable truck are described on page 7

State	The following operations are not possible
Withdrawable truck in service position, switching device "ON"	<ul style="list-style-type: none"> – Removal of the withdrawable truck – Opening of the door – Pulling of the LV plug
Withdrawable truck in service position, switching device "OFF"	<ul style="list-style-type: none"> – Removal of the withdrawable truck – Opening of the door – Pulling of the LV Plug
Withdrawable truck located between the service and test positions	<ul style="list-style-type: none"> – Closing of the switching device – Opening of the door – Pulling of the LV plug
Withdrawable truck in test position, switching device "ON"	<ul style="list-style-type: none"> – Transfer of the withdrawable truck to service position
Withdrawable truck in disconnected position LV plug pulled off, switching device "OFF", door open	<ul style="list-style-type: none"> – Closing of the door transfer of the withdrawable truck to service position.

1.3 Technical Data

1.3.1 Switching Device Compartment

Rated Voltage U_r	24/36 kV
Rated Power Frequency withstand Voltage U_w	50/70 kV
Rated Impulse Withstand Voltage U_p	125/170 kV
Rated short circuit breaking current I_{sc}	26.3 kA
Rated short time current (3s) rms	26.3 kA
Rated short time making current (peak)	65.75 kA
Rated current (maximum)	1250A

1.3.2 Vacuum Circuit Breaker

Rated Voltage U_r	24/36 kV
Rated Power Frequency withstand Voltage U_w	50/70 kV
Rated lightning impulse Withstand Voltage U_p	125/170 kV
Rated short time withstand current (rms) 3 secs	26.3 kA
Rated peak withstand current	65.75 kA
Rated short-circuit making current I_{ma}	65.75 kA
Rated short-circuit braking current I_{sc}	26.3 kA
Rated normal current I_r	800-1250 A
Pole centre distance	250 mm
Weight in	250 kg
Percentage of DC component	32%

Rating plate

1	Manufacturer	8	Weight
2	Type designation	9	Rated operating sequence
3	Serial number	10	Rated frequency
4	Design code	11	Rated lightning impulse withstand voltage
5	Year of manufacture	12	Rated short-circuit breaking current
6	Rated normal current	13	Rated voltage
7	Rated short-circuit duration		

	
Type (2)	Design Code (4)
Sr. No. (3)	Year of manuf. (5)
U_r (13) kV	f_r 50Hz (10) I_r (6) A
I_{sc} (12) kA	DC Comp. % t_k (7) s
U_p (11) kV	I_c A M (8) kg
Classification IEC 62271-100	
(9) Rated operating duty 0.3sec-CO-3min-CO	
MADE IN INDIA	
502-03-98200-001	

Fig. 6:



Closing time = the interval of time between the initiation of the closing operation and the instant when the contacts touch in all poles.

Opening time = the interval of time between the initiation of the opening operation and the instant when the contacts separate in all poles.

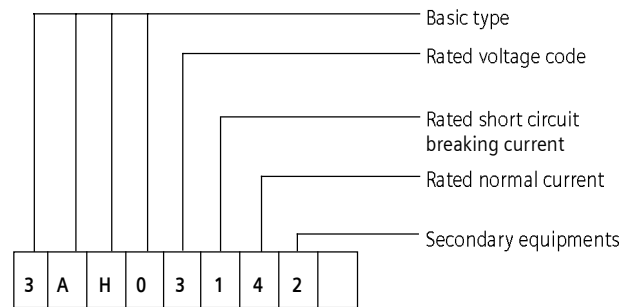
Arcing time = the interval of time between the instant of the first initiation of an arc and the instant of final arc extinction in all poles.

Break time = the interval of time between the beginning of the opening time of a circuit-breaker and the end of the arcing time.

Dead time = time from the end of the current flow in all poles up to the beginning of the current flow in the first pole.

Close-open time = the interval of time (in a make-break operating cycle) between the instant when the contacts touch in the first pole in the closing process, and the instant when the arcing contacts separate in all poles in the subsequent opening process.

Operating times

Closing time.....	ms < 80
Spring charging time..... (M1)	s < 15
Opening time..... with first shunt release 3AY15 10 (Y1).....	ms < 65
— do —..... with supplementary (second) shunt release 3AY15 10 (Y3).....	ms < 65
— do —..... with supplementary shunt release 3AX11 (Y2/Y4/Y7)	ms < 50 *
Arcing time	ms < 15
Break time	ms < 80
Break time	ms < 80
— do —..... with supplementary shunt release 3AX11 (Y2/Y4/Y7)	ms < 65
Dead time.....	ms 300
Close-open-time..... with shunt release 3AY15 10 (Y1).....	ms < 90
Close-open-time..... with supplementary (second) shunt release 3AY15 10 (Y3).....	ms < 90
Close-open-time..... with supplementary shunt release 3AX11 (Y2/Y4/Y7)	ms < 70
Close-open-time..... with fast acting shunt release 3AY15 10 (Y1)	ms < 70
Minimum pulse duration	
..... "Close"	ms < 45
..... "Open"	ms < 40
..... "Open"	ms < 40
..... "Open"	ms < 20
Shortest pulse duration of breaker tripping signal for first shunt release.....	ms > 15
Shortest pulse duration of breaker tripping signal for second shunt release.....	ms > 15
Shortest pulse duration of breaker tripping signal for third shunt release	ms > 10

* All releases designated as Y2, Y4, Y7 are imported

2. Installation

2.1 Transport Units

A transport unit consists of a single assembled SDC chamber panel complete with withdrawable truck.

The panel should not be lifted from the top with circuit breaker inside.

2.2 Packing

As required :

- (a) For shipment to inland destinations each transport unit is fixed on a sturdy wooden pallet and covered by plastic sheet for surface protection and packed in normal wooden case.
- (b) for shipment overseas each transport unit may be additionally packed in a seaworthy case. It is enclosed in plastic sheet, which is sealed air-tight and includes bags containing dessicant.

Accessories are packed separately, or kept in the panel transport unit (see dispatch advice).

Packing cases to be opened immediately prior to installation only.

2.3 Unloading

While unloading care must be taken to see that the panels are not rolled on its sides & they must be kept in upright condition.

2.3.1 Handling equipment required

- A mobile crane or a chain pulley block for unloading the transport unit.
- Lifting tackle
- A fork-lift truck with a fork length of about 3.0 mtr, for handling the switchgear inside the building.
- Pallet truck of 3 mtr length or two pallet trucks of smaller length inserted from front & rear side.
- Hydraulic jacks or winches & roller pads.

The handling/transport gear must meet the site requirements with regard to its construction and load bearing capacity. Refer to the weights (for raising and transporting) stated on the transport or in the covering documents.

2.3.2 Procedure

- Do not unpack while unloading the transport units. Take care not to damage the plastic sheet because it protects the switchgear against any environmental effects.
- Use of mobile crane..
- Attach the ropes to the wooden pallet.
- Carefully raise the transport unit and check to see that it is correctly balanced, if necessary lower the transport unit and correct any imbalance by repositioning the ropes on the lifting tackle.

2.4 Examining the switchgear against damage

As soon as the switchgear has been unloaded and unpacked examine it to see that it is complete. Record any damage and its cause without delay, in the presence of the forwarding insurance agent, if the damage was caused en route.

This report is essential for any damage claims.

2.4.1 Storage

- Store the packing cases in upright position only
- **The packing cases must be stored indoor such that they are protected from sun, rain, flood waters & other such natural elements**
- It is preferable to open the crates and polythene cover provided on the panel only before installation.

2.5 Transferring the transport units to their points of installation

- Transfer the transport units including their wooden pallets to the point of their installation using fork lift, mobile cranes or two pallet truck from both sides.
- Withdraw the trucks out of the panels using ramp & close the door. (Refer clause 2.5.1)
- Put the panels down on the cleaned site or at least immediately in front of it in the correct order, leaving a clearance of about 25 mm between them.
- To remove the transport units from their wooden pallets.
 - Remove the bolts fastened to the pallet.
 - Lift the cubicles slightly by using crow bars.
 - Insert the first roller pad beneath the panel.
 - Repeat the same for the other side.
 - To unload the pallet, move the cubicle forward or backward on the pallet until the panel can be tilted.

2.5.1 Removing the Truck from the Panel

- Bring the truck to the test position by cranking (Refer clause 4.1.3.1)
- Open the door of the panel (Refer clause 4.6.1).
- Disconnect the LV plug (4.3, Fig 4) & place it its holder (4.6, Fig 4) on the door.
- Mark the truck & their panel numbers for identification.

2.6 Assembling the Switchboard

Carry out the work described under clauses 2.5.1, 2.6.1, 2.6.2.

Keep the bolts loose, not fully tightened, till all the bolts for sections are in position. Then tighten the joining bolts, followed by Busbar bolts, followed by Foundation bolts.

2.6.1 Joining of the Panels

For the purpose of joining the panels at site, an inter panel coupling holes are provided on the sides of each SDC chamber. It is OEM's responsibility to couple the complete panel to the adjacent panel.

2.6.2 Fixing the Switchboards to the Foundation

The panels bottom plate has four 30 mm x 30 mm cutouts (refer Fig 15) for fixing purposes.

- **Welding**

Weld the bottom plate to the foundation at the cutouts. Insert shims where necessary to avoid having to weld across air gaps.

Coat the weld with enamel paint.

- **Bolting Down**

Embed anchor-bolts in the foundation (through the 30 mm x 30 mm cutout) or drill the appropriate holes in the foundation rails (false floor).

Insert shims between the foundation and the bottom rails near the cutouts.

Tighten the screw without distorting the panels.

2.7 Earthing of the Switchboard

Connect the earth terminals of at least one or two panels to the station earth. This could be done to suit the local guidelines. Termination facility for earth connection is provided on the earth busbar mounted in the Switching Device Compartment.

2.8 Other work to be carried out

2.8.1 Cleaning the Switchboard

- Clean all the post insulators, bushings and busbars in all the compartments using soft dry cloth.

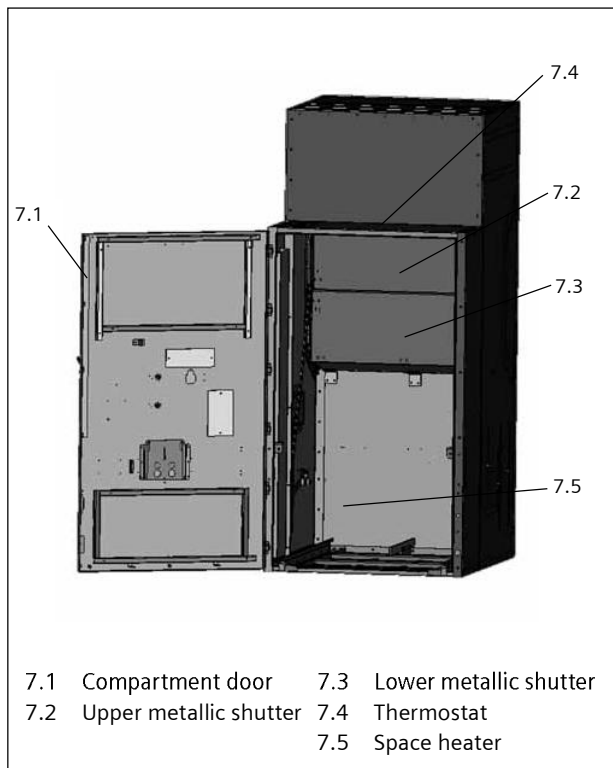

Fig 7: View into Circuit Breaker panel after removing the drawout truck

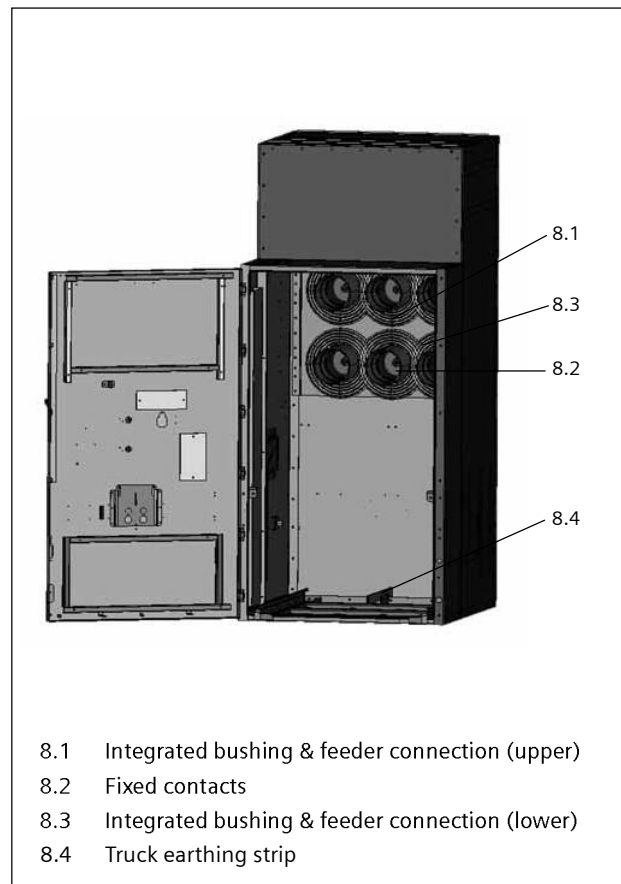

Fig 8: View into circuit breaker compartment with shutter held open

Do not use any abrasive chemicals or detergents to clean installed parts.

2.8.2 Inserting the withdrawable truck

- open the front door
- place the withdrawable truck in front of the corresponding panels.
- Transfer the truck inside the panel and push it as far as it will go.

Locking the VCB before rack in (Fig. 9a).

- Slightly tighten the top two bolts on LHS and RHS of front cross channel.
- Slide the handle on LHS and RHS as shown on the sticker.
- Tighten the top two bolts.
- Start rack in.

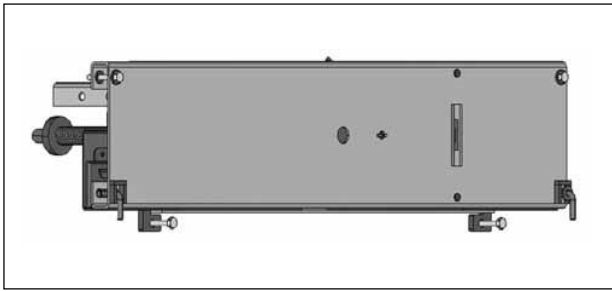

Fig 9a

Unlocking VCB (Fig. 9a)

- Slightly loosen the top two bolts on LHS and RHS of front cross channel.
- Pull the pins outwards and ensure that handles are fully slid inside.
- Loosen the top two bolts fully.
- Please ensure that the rotating plate is locked at the bottom of the panel as shown in the (Fig. 9b) on both sides, after VCB is racked in. (clockwise for RHS & anticlockwise for LHS)
- Close the door.
- Insert the double bit key and turn clockwise.
- Insert all other withdrawable trucks in the same manner.

2.8.3 Protecting the panels against environmental effects

- (a) Damaged sections of the paint finish may only be touched up with original paint.
- (b) Fit the parts supplied to protect against the ingress of reptiles. Check in case they are removed during installation.
- (c) Close all the doors & covers properly.
- (d) Any opening that is left open after installation should be closed & sealed to make it truly verminproof.

2.9 Module Wiring

The SDC is supplied with a loose plug (32 or 64 pin) It is OEM's responsibility to connect the appropriate wiring for the supply of VCB and the proper bunching and routing of the wires and cable to Loe Voltage compartment.

Module Wiring - The SDC is supplied with a loose plug (32 or 64 pin) It is OEM's responsibility to connect the appropriate wiring for the supply of VCB and the proper bunching and routing of the wires and cable to Loe Voltage compartment.

2.10 Circuit Breaker wiring

The wiring of circuit breaker is shown in the circuit diagram supplied depending on the equipment. Typical diagrams for circuit breakers are shown in Fig. 10 to 13.

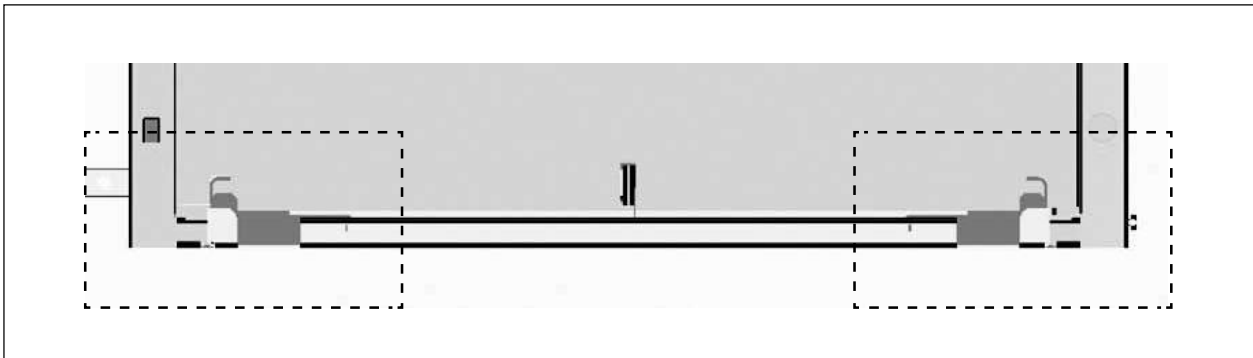

Fig 9b

Function schematic diagram

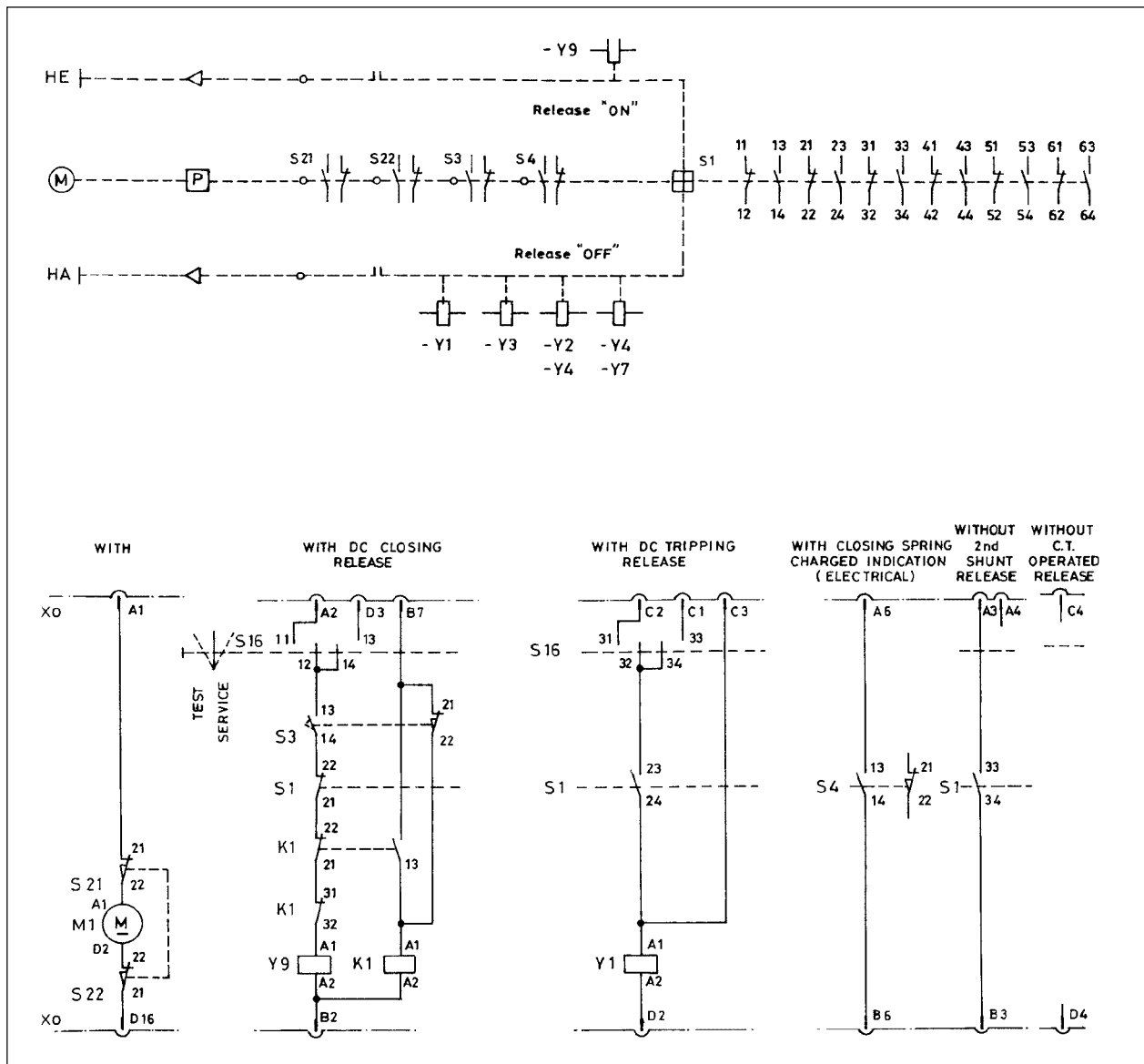

Fig. 10: 3AH0 VCB with electrical manual closing with 64-pin socket.

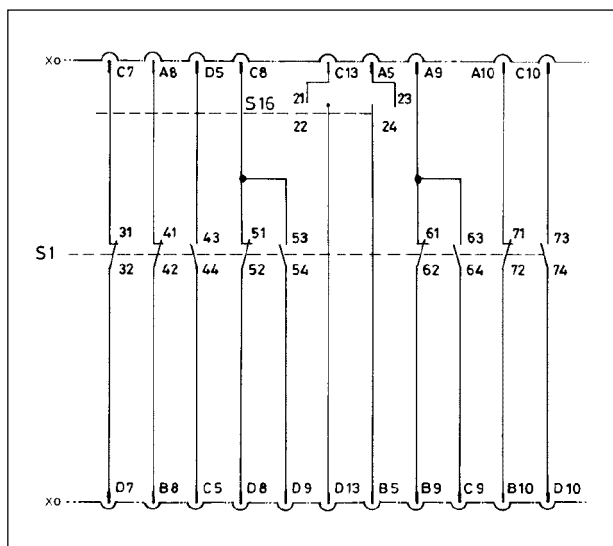

Fig. 11: Remaining contacts of aux. switch (6NO + 6NC)

- HA Manual tripping
- HE Manual closing
- K1 Anti-pumping device
- M1 Motor operating mechanism
- P Energy store
- S1 Auxiliary switch
- S21, S22 Position switches (cut-out motor after charging of closing spring)
- S3 Position switch (opens when closing spring charged)
- S4 Position switch (signals charged state of closing spring)
- X0 Socket of low-voltage plug connector
- Y1 1st Shunt release
- Y2/Y3 2nd Shunt release
- Y4 CT operated release
- Y7 Undervoltage release
- Y9 Closing release
- S16 Aux. switch (operates in test & service positions) is mounted on VCB truck
- V1 - V3 Rectifiers for motor, tripping / closing releases

Function schematic diagram

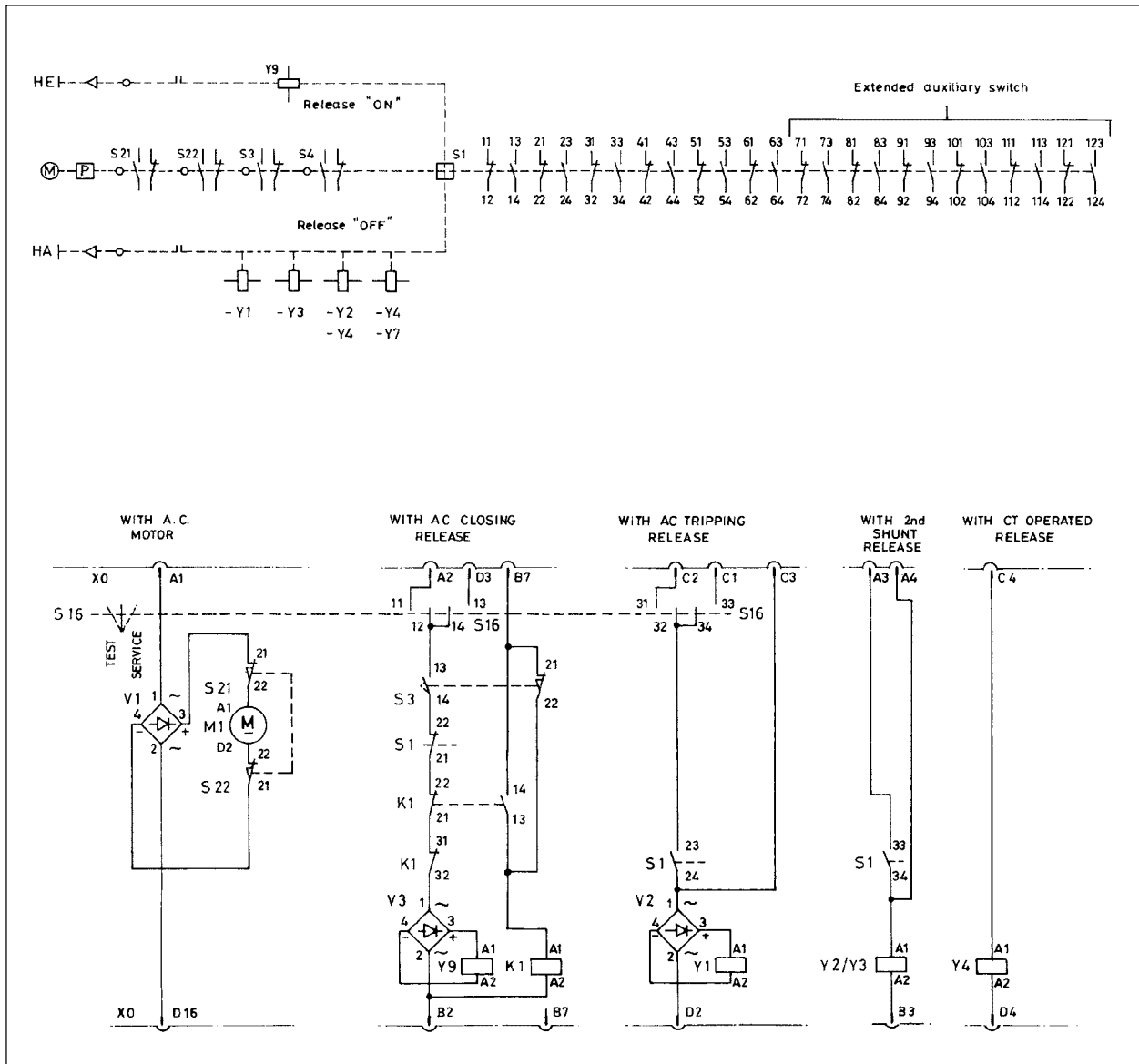

Fig. 12: 3AH0 VCB with electrical manual closing with 64-pin socket.

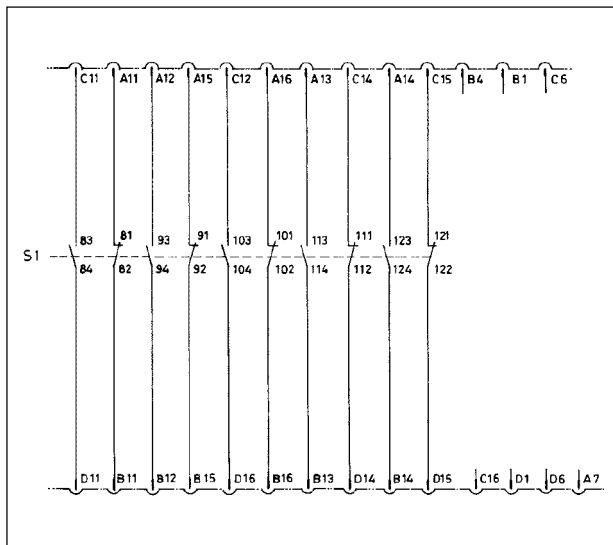



Fig. 13: Extended aux. switch (12NO + 12NC)

- HA Manual tripping
- HE Manual Closing
- K1 Anti-pumping device
- M1 Motor operating mechanism
- P Energy store
- S1 Auxiliary switch
- S21, S22 Position switches (cut-out motor after charging of closing spring)
- S3 Position switch (opens when closing spring charged)
- S4 Position switches (signals charged state of closing spring)
- X0 Socket for low-voltage plug connector
- Y1 1st Shunt release
- Y2/Y3 2nd Shunt release
- Y4 CT operated release
- Y7 Undervoltage release
- Y9 Closing release
- S16 Aux. switch (operates in test & service positions) is mounted on VCB truck
- V1 - V3 Rectifiers for motor, tripping / closing releases

3. Putting the switchgear into service

For details of operation refer section 4



Caution

When moving the circuit-breaker on truck to connected (service) position ensure that it is in

- Open (off) position,
- closing spring discharged and
- in the test position



Caution

When moving the circuit-breaker on truck to disconnected (test) position, ensure that it is in

- Open (off) position,
- closing spring discharged and
- in the service position

Note: Complete Switch gear is in scope of the OEM manufacturer and proper instruction for installation and commissioning shall be provided by the OEM manufacturers.

3.1 Test operations

3.1.1 With door open

- The motor operating mechanism start as soon as the LV plug is inserted and control supply is available (If the VCB is not already charged)

- Open & close the breaker several times.
- Pull off the LV plug. Charge the breaker closing spring by hand (refer clause 4.2)
- Operate the circuit breaker
- Refit the LV cable plug.

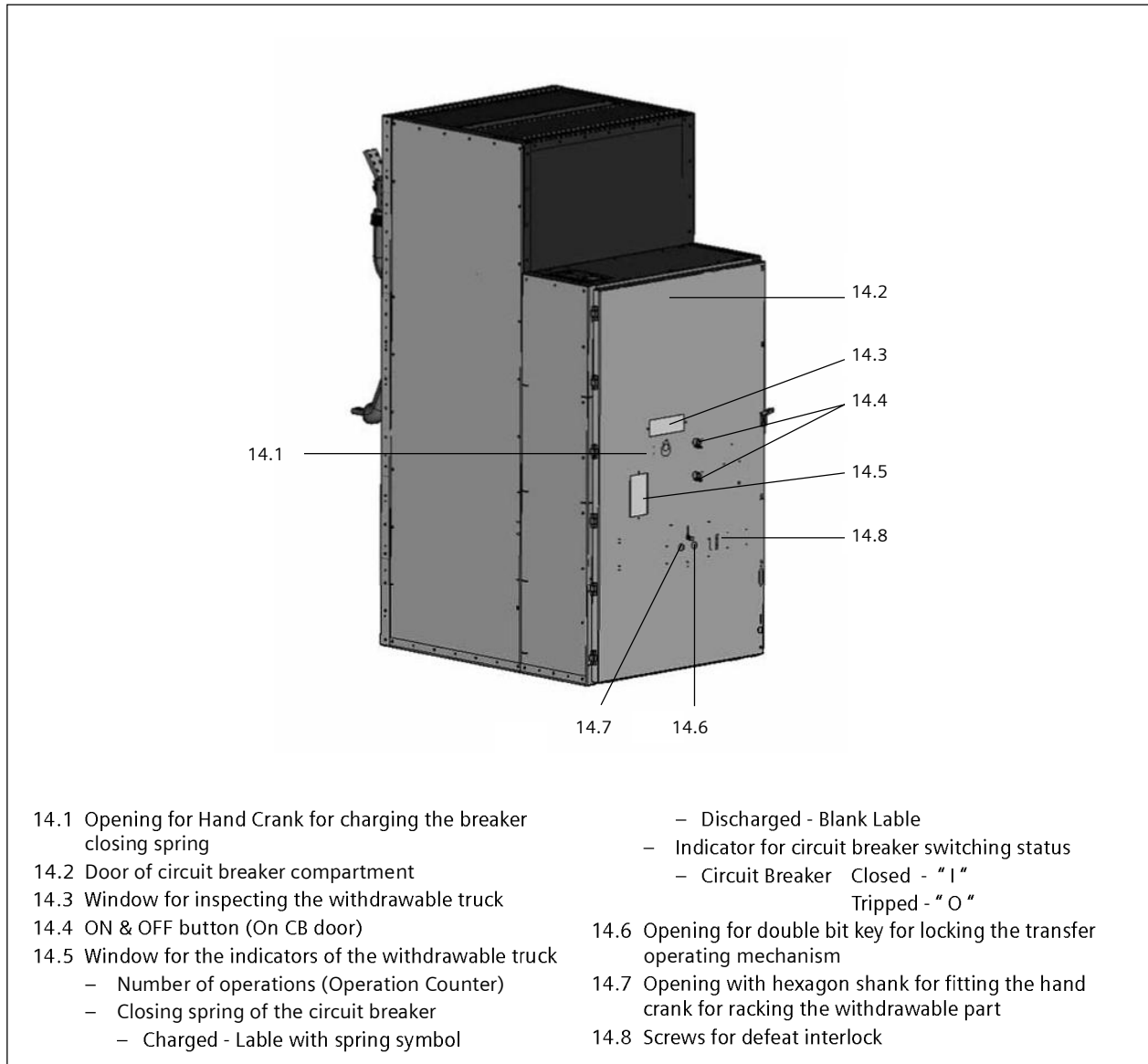
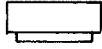
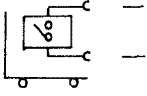
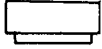
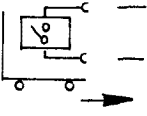
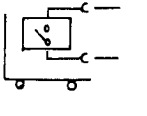



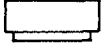



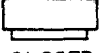
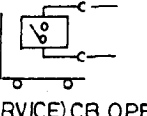



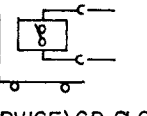
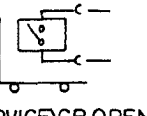

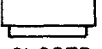
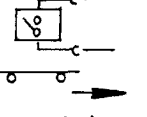
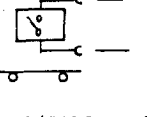



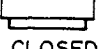
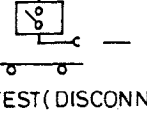



Fig 14: Opening Elements

SIEMENS

BRIEF OPERATING INSTRUCTIONS FOR 8BK80 SWITCHGEAR

TRUCK POSITION	FRONT DOOR POSITION	DESIRED POSITION OF TRUCK & CB		OPERATION OF KEY & CRANKING LEVER IN CB COMPARTMENT
		FROM	TO	
INITIAL TEST (DISCONNECTED)	 CLOSED	 TEST (DISCONN.)	—	—
MOVE FROM TEST (DISCONNECTED) ↓ TO SERVICE (CONNECTED)	 CLOSED	 TEST (DISCONN.)	 SERVICE (CONN.)	1. INSERT KEY  TURN 90°  2. INSERT CRANKING LEVER TURN  TILL STOP 3. REMOVE CRANKING LEVER
LOCK IN SERVICE POSITION	 CLOSED	 SERVICE (CONN.)	—	1. TURN KEY  90°  2. REMOVE KEY
MECHANICAL OPERATION OF CB IN SERVICE POSITION	TO CLOSE CB  CLOSED	 (SERVICE) CB OPEN	 (SERVICE) CB CLOSED	PRESS ON PB  → 
	TO OPEN CB  CLOSED	 (SERVICE) CB CLOSED	 (SERVICE) CB OPEN	PRESS OFF PB  → 
MOVE FROM SERVICE (CONNECTED) ↓ TO TEST (DISCONNECTED)	 CLOSED	 SERVICE (CONN.)	 TEST (DISCONN.)	1. INSERT KEY  TURN 90°  2. INSERT CRANKING LEVER TURN  TILL STOP 3. REMOVE CRANKING LEVER
LOCK IN TEST POSITION (DISCONNECTED)	 CLOSED	 TEST (DISCONN.)	—	1. TURN KEY  90°  2. REMOVE KEY

FOR DETAILED DESCRIPTION OF ABOVE OPERATIONS & SPRING CHARGING OF CB,
OPENING/CLOSING OF DOOR, ETC.

REFER CLAUSE 4 OF THIS MANUAL

Fig 15: Label on door of breaker compartment

3.1.2 With door closed

Each panel should be tested as follows:

- Transfer the withdrawable truck to the disconnected position (see 4.1).
- Switch ON the auxiliary and control supply.
- Transfer the withdrawable part to the connected position.
- Open and close the breaker as long as no high voltage is applied.
- Without using force check all mechanical and electromechanical interlocks for satisfactory functioning. Check to see whether the switching states are indicated correctly in the control room.
- Check whether the position of the withdrawable truck is indicated correctly (if the appropriate position switches are fitted refer to the circuit diagrams).

3.2 Checking the Accessory Items

The accessory items required must be easily available in the Switchgear Room or an adjacent room. They include one hand crank for transferring the truck and for charging the breaker closing spring, a double bit key for locking the hand-operating mechanism, operating instructions, castell lock key (optional), earthing switch handle (Optional).

The hand crank for transferring the truck is also suitable for all M8 bolts.

3.3 Space Heaters

Space heaters are fitted in the circuit breaker. The thermostat controlled heaters should be switched "ON" before taking the panels into service. The thermostat shall be set to cut off supply to heaters at about 5° higher than the maximum ambient temperature.

Heaters must always be kept "ON" in all the conditions (even during maintenance)

4. Operations

4.1 Withdrawable truck

4.1.1 Positions of the withdrawable truck

- **Service position (connected position)**

The circuit breaker is connected with the busbars and the outgoing circuit. Auxiliary circuit is connected through LV plug and socket.

- **Test position**

The circuit breaker is disconnected from the busbars and the outgoing circuit. Segregation as specified in IEC 62271-200 is maintained. The LV circuits are connected through LV plug and socket.

Disconnected position

The circuit breaker is disconnected from the busbars and the outgoing circuit. LV circuits are disconnected by pulling out the LV socket from the plug.

- When the LV plug and socket are connected the following functions can be carried out.
 - The breaker can be tested / operated, also from the control room.
 - The breaker compartment door can be opened.
 - Functions such as ON / OFF indication and electrical interlocks can be tested.
- When the LV plug and socket are disconnected.
 - The breaker compartment door cannot be closed. Hence the truck cannot be inserted.

4.1.2 Transferring the withdrawable part from the Test/Disconnected Position manually

4.1.2.1 Normal operation

In brief:







1st Step Turn double-bit key			2nd Step Insert and turn hand crank	3rd Step Turn double-bit key		
from	by	to	as far it will go and pull it of	from	by	to
						

Fig 16a

In detail:

- Make sure that the circuit breaker is open, the LV plug (4.3, Fig. 4) and socket has been put together and locked up with the clip (4.7, Fig. 4). The breaker compartment door is closed.

- Fit the cranking handle (5.2, Fig 5) to the hexagon shank in opening (14.6, Fig 14) turn it clockwise as far as it will go and pull it off.
- Turn the key through 90 degrees from position “Manual Racking” to “Connected position (locked)” and pull it off.

4.1.3 Transferring the withdrawable part from the connected position to the test/disconnected position manually

4.1.3.1 Normal Operations

In brief







1st Step Turn double-bit key			2nd Step Insert and turn hand crank	3rd Step Turn double-bit key		
from	by	to	as far it will go and pull it of	from	by	to
						

Fig 16b

In detail:

- Make sure that the circuit breaker is open.
- Insert the double bit key in lock (14.6, Fig 14) and turn it anti-clockwise through 90 degrees from “connected position (locked)” to “Manual Racking”. The hexagon shank opening (14.7, Fig 14) is now accessible. The hand racking mechanism is unlatched.
- Fit the hand crank (5.2, Fig 5) to the hexagonal shank in opening (14.7, Fig 14) turn it anti-clockwise as far as it will go and pull it off.
- Turn the double-bit key clockwise through 90 degrees from the position “Manual Racking” to “Disconnected position (locked)” and pull it off.

Opening (14.7, Fig 14) is now closed.

The hand racking mechanism is now locked.

4.1.3.2 Castell Key Operations







1st Step Turn castell key			2nd Step	3rd Step Turn castell key		
from	by	to	as far it will go and pull it of	from	by	to
						

Fig 16c

In detail:

- Make sure that the circuit breaker is open.

- Turn the castell key (which is trapped in the mechanism) anti-clockwise through 90° from “Connected position (locked)” to “Manual Racking”.
- In this position the castell key can be removed for any interlocked operations which are to be performed with circuit breaker in open condition. The hexagon shank opening (14.5, Fig 14) is now accessible.

The hand racking mechanism is unlatched.

- Fit the hand crank (5.2, Fig 5) to the hexagonal shank in opening (14.5, Fig 14) turn it anti-clockwise as far as it will go and pull it off.
- Insert the castell key if it was removed for interlocked operations. Turn the double-bit key anti-clockwise through 90 degrees from the position “Manual Racking” to “Disconnected Position (locked)” and pull it off.
- The castell key can also be removed in this position to facilitate the opening of the CB compartment door and / or other interlocked operations.

4.1.4 Removing the LV Plug

- Transfer the withdrawable part to the disconnected position (in accordance with clause 4.1.3) and lock it.
- Open the breaker compartment door (refer clause 4.6.1).
- Unlock the plug (4.3, Fig. 4) and socket connector by turning down the clip (4.7, Fig 4).
- Pull off the plug and attach it to the holder (4.6, Fig 4) which is fixed to the door.

4.1.5 Connecting the LV Plug

- Put the plug (4.3, Fig 4) and socket connector together and lock it with the clip (4.7, Fig 4).
- Close the breaker compartment door (refer clause 4.6.2).

4.2 Circuit-breaker operating mechanism

The operating mechanism is of the stored energy type. For electrically operated breakers, motor automatically charges the closing spring after each switching operation. If the motor supply fails, the closing spring can also be charged by hand. The tripping spring is charged each time the breaker is closed.

4.3 Circuit-breaker Operation

4.3.1 Charging the closing spring by hand

- **Procedures**
- **Operating Mechanism**
- Turn the crank until the symbol “spring charge” appears in viewing window (14.3, Fig 14) on indicator. The operator is not at risk if the motor supply recovers, because the hand crank free-wheels and detaches in the anti-clockwise direction.
- Pull the crank off.

4.3.1.1 Breaker ON and OFF

- 4.3.1.2 **Mechanically** insert the handle in respective role to switch ON/OFF the VCB.

- 4.3.1.3 **Electrically** (from the control room or locally) by means of push button/switches in the control room or on the LV compartment door. If the control supply fails the breaker can always be tripped mechanically (see above)

4.3.2 Switching State Indication

In the middle part of viewing window (14.5, Fig 14) ‘O’ means “OFF”, ‘I’ means “ON”.

4.4 Earthing

4.4.1 Earthing of Busbars or cables with a Drawout Truck (Fig. 32)

Separate drawout Trucks can be supplied optionally for busbar and cable earthing. In case fault making capacity is required, a circuit breaker is mounted on such drawout trucks.

- **Procedure**

- Remove the circuit breaker or the link drawout truck from the panel where earthing is to be done (refer clause 2.5.1)
- Insert the desired earthing drawout truck i.e. cable or busbar earthing drawout truck in the panel (refer clause 2.8.2)
- Connect the LV plug and socket (refer clause 4.1.5)
- Close the panel door (refer clause 4.6.2)
- Ensure that there is no voltage available on the parts to be earthed when earthing drawout truck without making capacity is used.
- Transfer the drawout unit to the connected position (refer clause 4.1.2).

In case the earthing drawout truck has an electro-mechanical interlock unit mounted on it, the transfer is possible only after all the interlocking conditions are satisfied.

- Lock it in the connected position.
- In case the drawout truck has a circuit breaker mounted on it switch “ON” (refer clause 4.2 & 4.3).
- Place the warning plates at all necessary locations.

4.4.1.1 Disconnection of Earthing Drawout truck

- Switch “OFF” the breaker in case of earthing drawout truck with making capacity (refer clause 4.3).
- Transfer it to the disconnected position (refer clause 4.1.3)
- Open the HT compartment door (refer clause 4.5.1)
- Disconnect the LV plug (refer clause 4.1.4)

- Insert the original drawout truck of the circuit breaker or link drawout truck in the panel (refer clause 2.8.2)
- Connect the LV plug (refer clause 4.1.5)
- Close the door (refer clause 4.5.2)
- The original drawout truck is now ready for transfer to connected position.
- Remove warning plates.

4.5 Breaker Compartment Door

The door can be opened & closed when the truck is in the disconnected position and the plug & socket connector for LV cables has been connected together.

The door interlock can be defeated as described under clause 5.5 below.

4.5.1 To open the door

- Unscrew all M8 bolts
- Open the door

4.5.2 To close the door

- Shut the door
- Tighten the bolt

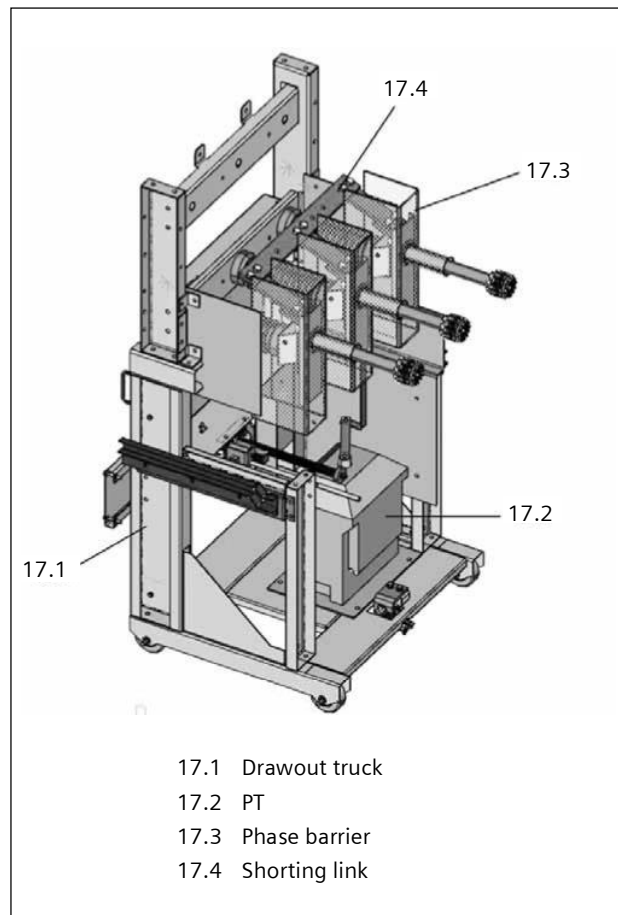

Fig 17: Drawout earthing truck

5. Maintenance



Danger Precautions for Safe Working

Maintenance, repair and subsequent conversion or extension work shall be carried out only by specially trained personnel in accordance with the operating instructions and/or special conversion instructions. Training and information sessions for personnel will be provided by the competent Siemens department.

Before starting any work on the panels/VCB references must be made to local regulations for high voltage switchgear. Switch off the power supply, close/open the breaker manually to ensure that the closing spring of the breaker is discharged. Then rack out the truck from service to test position.

Control terminals in the LV compartment must not be touched if the control supply is not disconnected.

Non observance will result in death and / or severe personnel injury or substantial damage to property.

5.1 Switching Device Compartment

5.1.1 Inspection Schedule

- Each year
 - Make a general visual check.
 - Check whether the accessories are complete and in proper order.
 - Clean and lubricate the wheels as well as moving parts of the truck and interlocking plate.
 - Clean the compartment (refer clause 5.2)
- Every five years
 - Transfer the withdrawable truck to the disconnected position.
 - Test-operate the circuit-breakers.
 - Remove the withdrawable trucks (refer clause 2.5.1) and carry out all maintenance work, also on the switching devices.
 - Clean the panels (refer clause 5.2) and check the connections.
 - Lubricate all bearing surfaces, bearings and articulated joints.
 - Reinsert the withdrawable trucks.
 - Check the switchgear panel functions and put the board back into service.

If work has to be carried out in the panels; isolate the board, make sure that it cannot be made live again, check its isolated state and earth and short-circuit the feeders and where applicable. Adhere to all regulations and safety measures, maintain and service the built-in equipment, e.g. circuit-breakers in accordance with their operating instructions.

Before removing the front plate of the breaker operating mechanism discharge the closing and tripping springs. Follow the instructions given on the mechanism housing.

Only standard tools are required. Put the switchgear back into service as described under clause 3 above. **Service the switchgear at shorter intervals if the air is very moist or full of dust or is otherwise polluted.** The cause of any disturbance or short-circuit must be determined immediately and damaged parts replaced, irrespective of whether an inspection is due or not.

5.1.2 Cleaning



Caution For Safety

For safety reasons, cleaning of panels shall be taken up only when the shutdown of Main & Auxilliary Power supply is taken, the breaker is in the open state, closing spring of the breaker is discharged & the breaker truck is removed out of the panel.

Cleaning Agents

Perchloroethylene, 1.1.1 trichloroethane, small brushes, dusters and vacuum cleaner for sheet metal parts.

Note:

Trichloroethylene, perchloroethylene and tetrachloroethylene have a harmful effect on cast resin parts and must not come into contact with them.

Cast resin parts should be cleaned with clean cloth only.

Silver plated and other contact surfaces to be cleaned with clean cloth.

5.1.3 Lubrication

Immediately after cleaning:

- Lubricate the isolating contacts and their mating contacts with neutral grease.
- apply a film of neutral grease to the bearings and articulated joints of the operating mechanisms, to the withdrawable parts and shutters, and to the door hinges and locks.

Recommended neutral greases are:

- (i) SERVOGEM 2 (multipurpose) of Indian Oil Corporation make
- (ii) Multipurpose grease 'H' of Hindustan Petroleum Ltd. make
- (iii) Any other chemically neutral grease which can withstand temperature up to 15° C.

5.2 VCB

5.2.1 Maintenance schedule

Sequence No.	Work	Materials	Frequency			Remarks
			If required / annually	10,000 mech. operating cycles	30,000 mech. operating cycles	
1.	Circuit-Breaker					
1.1	Visual inspection and cleaning if necessary		X	X	X	–
1.2	Cleaning of cast resin components	– Clean cloth	X	X	X	See note 1)
1.3	Grease bearings and sliding surfaces as shown in Fig. 34. Perform 3 to 5 test operations of ON/OFF.	– Isoflex Topas L32 grease – Shell Tellus 32 oil		X	X	See Fig. 24 Note 2 Note 3
2.	Breaker pole					
2.1	Replace vacuum interrupters				X	While ordering replacement interrupters, state CB type, design code and serial number (see rating plate) Note 4
3.	Breaker operating mechanism					
3.1	Replace motor M1			X	X	
3.2	Replace closing spring				X	
4.	Examine and replace if necessary					Note 5/Note 6
4.1	All electrical devices in the drive			X	X	
4.2	Check all cable/ wires for firmfit			X	X	
4.3	Leaking of shock-absorber			X	X	

Fig. 18

Notes:

- 1) If the 3AH0 vacuum circuit-breaker is used in unfavourable indoor conditions (strong, and frequent moisture condensation, dust-laden air etc.), we recommend that the insulating parts and, if necessary, the external breaker parts be regularly cleaned at frequent intervals.
 - 2) Joints and bearings which cannot be dismantled **must not** be treated with a cleaning agent prior to reapplication of anticorrosives.
 - 3) Lubricants:
 - Bearings, sliding surfaces:
Isoflex Topas L 32
 - Bearings inaccessible to grease and bearings of the auxiliary switch S1:
Shell Tellus 32
 - 4) The securing fasteners used on all replaced parts must also be renewed (spring washers, lock washers, splints, etc.).
An assortment of securing fasteners are offered by Siemens Representative Office.
Order number 3AY1550-0A
 - 5) The snap switches must not be fitted too tightly; i.e. the plunger of the position switch must move freely.
 - 6) Replace only if necessary, e.g. if the switching times are no longer complied with or mechanical damage has occurred.
- Lubricants (for special requirement) are available from the Siemens agency on enquiry.

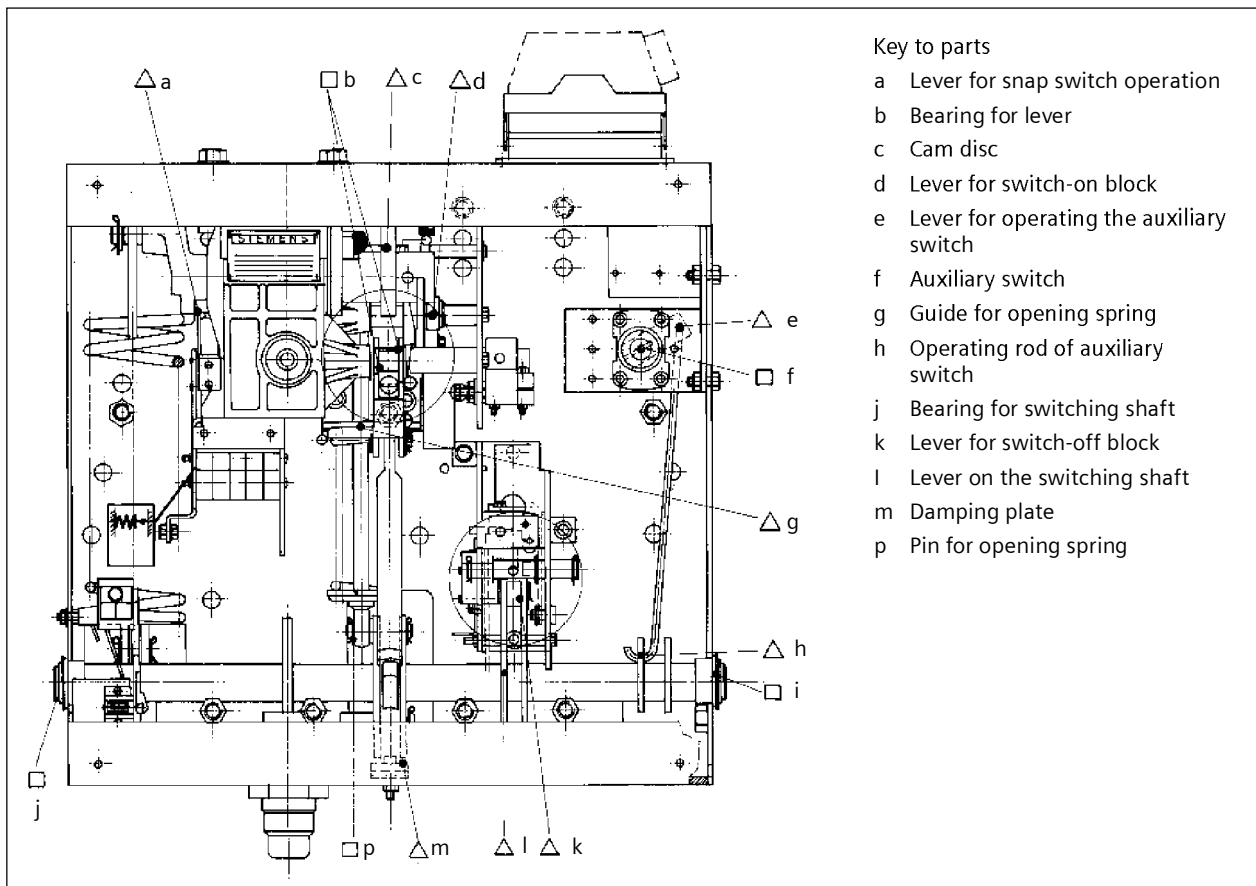

Fig. 19

△ Isoflex Topas L32 grease
 □ Shell Tellus 32 Oil

5.2.2 Servicing

General

The 3AH0 vacuum circuit-breakers are maintenance-free up to 10,000 operating cycles. By virtue of their design and a special routine testing process they can be used for up at least 30,000 cycles. In order to uphold the high level of reliability throughout the entire operating life, we recommend regular maintenance after every 10,000 operating cycles. The scope of maintenance work depends on the following operating conditions:

- Ambient conditions (temperature, air, humidity, etc.)
- Continuous current stress
- Number of electrical operating cycles
- Number of mechanical operating cycles



Danger

Precautions for Safe Working

High Voltage !

Touching live parts will result in severe personnel injury and / or death.

This equipment shall be operated only by qualified personnel who have become thoroughly familiar with the operating instructions manual and in particular all the safety instructions.

5.2.3 Troubleshooting of 3AH0 VCBs

Problem	Symptoms / Effect	Possible Causes / Reasons	Remedial Measures
Breaker fails to close.	1. Closing spring charges, but breaker does not close.	1. Electrical power to auxiliary circuit is off, or control fuses have blown.	1. Check electrical power to auxiliary circuit and/or replace blown fuses.
		2. Loose connection, damage to wiring.	2. Check & repair as necessary.
		3. No closing command to terminal 19 or A2 of socket	3. Check for continuity & correct logic circuit.
		4. Plug & Socket are not engaging.	4. Check & repair.
		5. Unoperational closing release.	5. Test closing release separately & then replace, if not operating.
		6. Aux. switch (S1) contacts 21-22 are open when the breaker is closed.	6. Check & adjust mechanical linkage with aux. switch.
		7. Unoperational anti-pumping contactor (K1) & its contacts	7. Check & replace, if necessary.
	2. Closing spring does not charge automatically.	1. Electrical power to auxiliary circuit is off, or control fuses have blown.	1. Check electrical power to auxiliary circuit and/or replace blown fuses.
		2. Loose connection, damage to wiring.	2. Check & repair as necessary.
		3. Plug & Socket are not engaging.	3. Check & repair.
4. Unoperational charging motor.		4. Check & replace.	
5. Limit switches S21 & S22 fail to operate		5. Check & contact authorised service limit switch & correct.	
6. Mechanical failure of operating mechanism.		6. Check & contact authorised service centres.	
3. Closing release operates, sound of breaker closing is heard, but breaker contacts do not close.	Mechanical failure of operating mechanism.	Check & contact authorised service centres.	
Nuisance or false closing of breaker	1. Electrical problem	1. Closing command continues on terminal 19 or A2.	1. Check & correct logic circuits.
		2. Terminal A2 of closing release is shorted to earth.	2. Check to find out if problem in wiring or release. Correct as per requirement.
	2. Mechanical problem	Mechanical failure of operating mechanism	Check & contact authorised service centres.
Breaker does not trip.	1. Tripping Release (Y1) does not trip.	1. Electrical power to auxiliary circuit if off, or control fuses have blown.	1. Check electrical power to auxiliary circuit and/or replace blown fuses.
	2. There is no tripping sound.	2. Loose connection, damage to wiring.	2. Check & repair as necessary.
		3. No tripping command to terminal 4 or C2 of socket.	3. Check for continuity & correct logic circuit.
		4. Plug & Socket are not engaging.	4. Check & repair.
		5. Unoperational tripping release.	5. Test tripping release separately & replace, if not operating.
		6. Aux. switch (S1) contacts 23-24 are open when the breaker is closed.	6. Check & adjust mechanical linkage with aux. switch.
Nuisance or false tripping of breaker	1. Electrical problem	1. Tripping command continues on terminal 4 or C2.	1. Check & correct logic circuits.
	2. Mechanical problem	2. Mechanical failure of operating mechanism.	2. Check & contact authorised service centres.

6 Defeating the Door Interlock of HV Compartment

Caution: Take utmost care while defeating any interlock as the defeat operation leads to access to the areas / parts which are likely to be live.

6.1 Drawout Unit in Connected Position

The breaker compartment door interlock should only be cancelled if the truck cannot be transferred to the disconnected position and the situation cannot be cleared in any way.

- Switch off the circuit -breaker.
- Make sure that the busbars are not live.
- Loosen M4 screw (2 Nos) (14.8, Fig 14)
- Open the door by turning the door handle.(refer clause 4.6.1).

6.2 Drawout Unit in disconnected position

- Press the interlocking lever on interlocking plate by hand.
- Insert the double-bit key in lock (14.6, Fig 14) and turn it (locked) to “Manual Racking”.
- Fit the hand crank (5.2, Fig 5) to the hexagon shank in opening turn it clockwise as far as it will go and pull it off (14.7, Fig 14).

Turn the double-bit key clockwise through 90° from position “Manual Racking” to “Connected Position (locked)” and pull it off.

6.3 Restoring the Door Interlocks

After carrying out the operations to defeat the door interlock as described in clause 5.5.1 or clause 5.5.2, the door of the compartment can be closed and interlocks can be restored.

- Assemble the interlocking piece using two M4 screws.
- Close the door and tighten all M8 bolts.

7 Disposal of Product

This product is environmentally compatible.

The following materials have been used to make up the device : Steel, Copper, Aluminium, Cast-resin glass-fibre-reinforced thermoplastics, rubber, porcelain, greases & similar materials. PVC is used as an insulation material for control wires.

In disposal, priority must be given to re-use of the materials which can be recycled.

In as-supplied-condition, the product does not incorporate any hazardous substances.

In operation, the product does not emit any hazardous materials or gases.

During disposal of the product, care must be taken to dismantle as far as possible in more environmentally accepted way as Recyclable & Non-cyclable scraps i.e steel, copper, aluminium, rubber, PVC, cast-resin & glass-fibre-reinforced materials to be segregated properly.

The Re-cyclable materials like Steel, Copper, Aluminium can be reused.

Non cyclable materials like Cast-resins, glass-fibre-reinforced etc can be broken in to pieces & can be used as secured land filling materials.

Rubber being biodegradable material must be recycled through authorized contractors.

PVC material should not be burnt as they may release Halogenated hydrocarbons which can affect the ozone layer. Therefore, PVC must be recycled through authorized contractors.

Local Siemens office can answer any questions concerning disposal.

8 Summary of Important Instructions

DOs	DON'Ts
<p>During Installation & Commissioning Stages:</p> <ol style="list-style-type: none">(1) Brush the contact surfaces properly before bolting busbars. Also grease the joints & apply proper torque on the bolts.(2) Check rated voltages of equipments such as motor, closing & tripping releases mounted in the operating mechanism with the available auxiliary supply to be connected to these equipments in the substation.(3) Ensure that all the foundation bolts are tightened along with the square washer and also seal of all control and power cable cutouts to prevent vermin entry. <p>During service life of the panel-</p> <ol style="list-style-type: none">(4) Keep door firmly closed to prevent entry of dust, moisture, insects etc.(5) Ensure spring charging handle & manual handle are available easily.(6) Decide maintenance schedule based upon (a) no. of short circuit operations, (b) frequency of breaker ON/OFF operations, (c) pollution level (d) humidity, etc.(7) Isolate & earth the breaker before carrying out maintenance & ensure it is in OFF position & springs are discharged completely before cleaning.(8) Ensure that the shutters are close and pad locked before starting the maintenance or cleaning of the panels.(9) Depending on site conditions, inspect<ul style="list-style-type: none">– the interior of the panels for dust, cobwebs etc. & clean them.– porcelain insulators & clean them,– operating mechanism parts such as plungers of releases, moving joints etc. & clean them, and– functioning of space heaters.(10) Lubricate moving parts with lubricants provided for the breaker.(11) Check insulation resistance with a megger before putting the breaker back into service.(12) Keep a log-book for each panel.(13) Follow instructions given in the operating manual.(14) Ensure panel operations, maintenance etc. is done by trained persons.(15) Operate the defeat interlock of CB door only in case of emergency.	<ol style="list-style-type: none">(1) Do not leave any equipments or tools in the panel.(2) Do not put hands or tools in operating mechanism when electrically operated.(3) Do not operate the breaker during cleaning process.(4) Do not use any other chemical or grease for clearing or lubricating other than mentioned in these instructions.(5) Do not lift the panel from the top with breaker inside.